

Safety Clamping Units

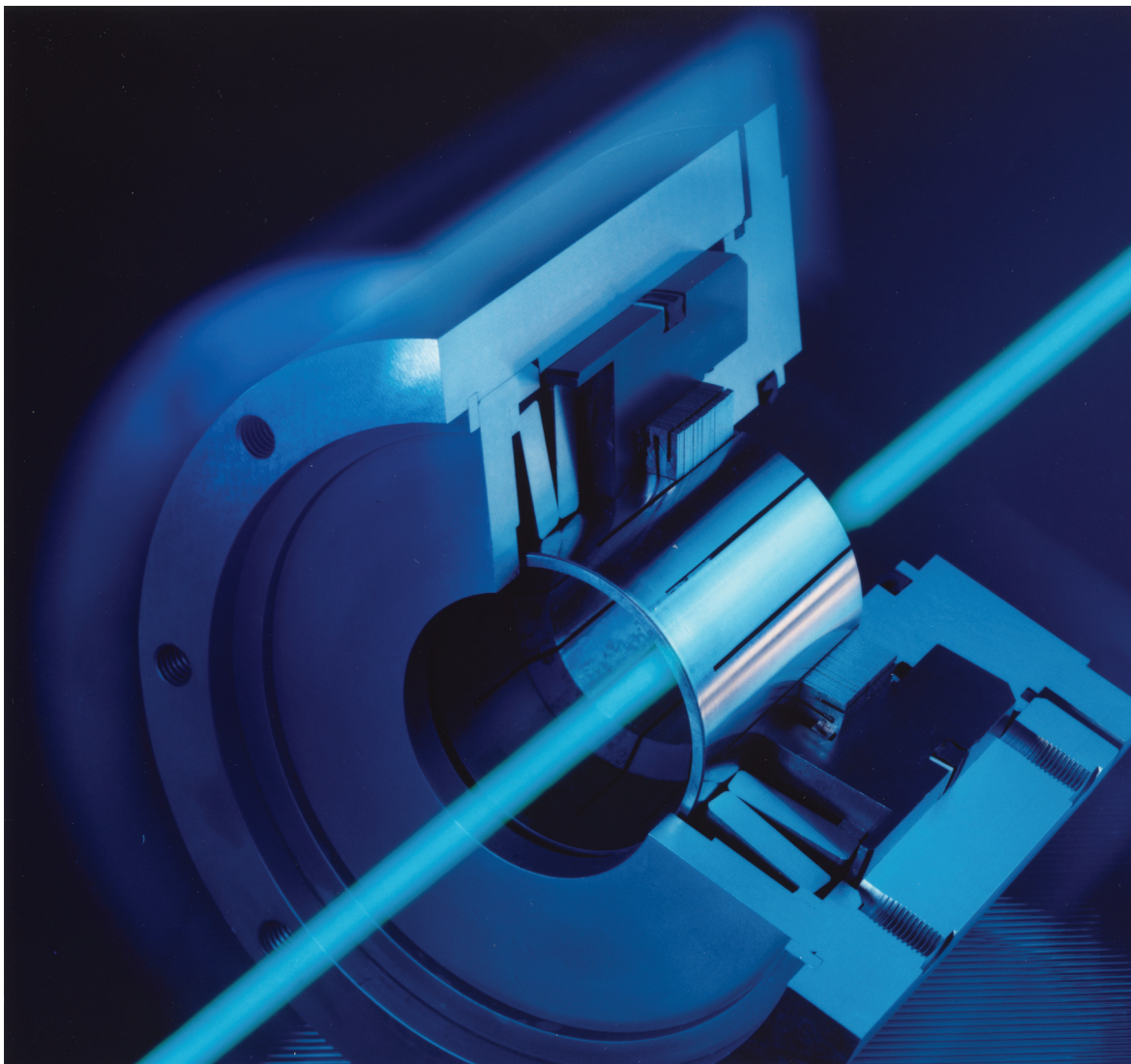

32

RINGSPANN[®] Registered Trademark of RINGSPANN GmbH, Bad Homburg

RINGSPANN Safety Clamping Units

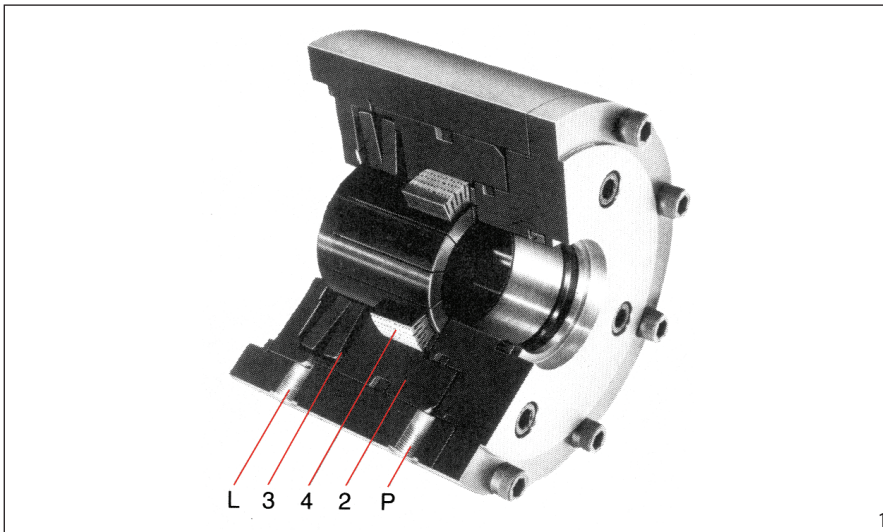

Description

The safety clamping unit „System RINGSPANN“ is an automatic and precise clamping machine element which clamps piston rods of hydraulic cylinders with a precalculated clamping force, independent of direction of movement. The clamping force is generated via built-in disc springs. The safety clamping unit is released by hydraulic pressure; it is therefore particularly well suited as a safety device.

The units are fitted to cylinders and other machine parts with a connecting flange.

Ill. 1 shows the core of the safety clamping unit „System RINGSPANN“; it can be flanged onto a hydraulic cylinder or, as shown in ill. 5, be used with a separate clamping cylinder.

Operation

The function of the safety clamping unit is explained by ill. 1. During the working stroke of the hydraulic cylinder, pressure is exerted onto connection P. Through this pressure the disc springs 3 are compressed via the pis-

ton 2 and the clamping discs 4 become axially free, so that the piston rod can be moved freely.

When the pressure on bore P is removed, the force of the springs 3 works fully onto the piston 2 and therefore also on to the disc pack. The clamping discs 4 transform this axial force into a radial force 5 times as large acting onto the clamping sleeve. The sleeve is slotted and therefore transmits the full radial force evenly onto the piston rod, thus making it absolutely immovable.

The built-in spring load makes the clamping unit particularly suitable for safety purposes, too. Each time the pressure falls – even when this was not planned – the clamping unit can be relied upon to respond immediately.

Range

The safety clamping unit is built in a series with 10 sizes covering loads of between 2.5 and 200 kN (see table). All the usual piston rod diameters between 12 and 115 mm are covered by the standard range.

Due to the high ‘transmission ratio’ of the discs very high holding forces can be achieved even with small piston rod diameters. Apart from that, higher or lower holding forces are possible with special types incorporating to a large extent parts of the standard range.

We also manufacture pneumatically releasable safety clamping units working to the same principle.

Application

The safety clamping unit secures the piston rod with precision against unintentional axial movements. For example, on machines with cylinders or linear motors a certain position can be driven in one continuous movement. With the safety clamping unit this position can then be held accurately mechanically. The accuracy of the safety clamping unit is independent of the size and the direction of the force on the piston rod up to the maximum holding force indicated. No movement of the piston rod is required for the holding force to become effective; on the contrary, the clamping force is effective immediately and does not depend on outside forces. If it is necessary to brake the movement of the piston rod, the safety clamping unit would, when pressure falls, produce virtually without delay a constant friction force independent of time. The slowing down of the piston rod is therefore even and protects the slowed-down components of the installation.

Technical Bureau of Standards

The technical approval was in accordance with the law for Materials – Machine Protection (FRG) and only applies to the clamping of a piston rod when stationary. A clamping action upon movement was not the object of the test.

Safety Clamping Units

spring activated - hydraulically released

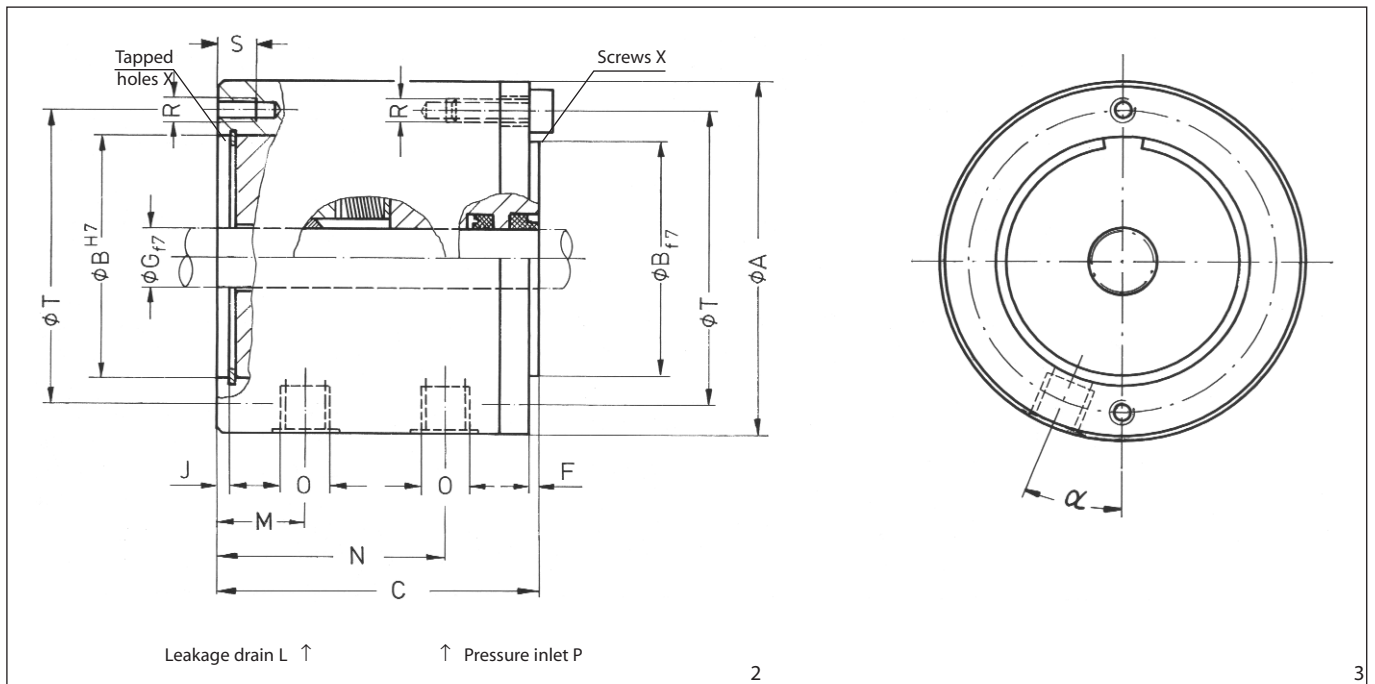

piston rod- ϕ G ¹⁾ mm	article no.	holding force F _H ²⁾ N	A mm	B mm	C mm	F mm	J mm	M mm	N mm	O	R	S mm	T mm	X ³⁾	necess. release press. bar	max. perm. press. bar	oil vol. approx. ⁴⁾ cm ³	α degree
12	4133.032.900	2500	72	48	76	2	5	26	54	R1/8"	M5	9	60	4	57	120	1	22,5
14	4133.037.902	5000	85	60	88	2	6	31	64	R1/8"	M6	11	72	4	68	120	2	22,5
16	4133.037.900																	
18	4133.037.901																	
20	4133.042.900	8000	100	68	100	2	6	34	72	R1/8"	M6	11	85	4	82	120	2	22,5
22	4133.042.901																	
25	4133.047.900	12500	110	80	115	2	7	42	85	R1/8"	M6	15	92	6	84	120	3	22,5
28	4133.047.901																	
(30)	4133.057.900	19000	130	95	130	2	7	48	96	R1/4"	M8	16	112	6	88	120	5	22,5
32	4133.057.901																	
34	4133.057.902																	
36	4133.070.902	30000	150	116	148	3	4	52	108	R1/4"	M8	16	132	8	102	120	6	22,5
40	4133.070.900																	
45	4133.070.903																	
50	4133.090.900	48000	178	140	168	3	8	52	119	R3/8"	M10	20	160	8	108	160	13	22,5
(55)	4133.090.901																	
56	4133.090.902																	
60	4133.105.900	68000	210	168	185	3	10	60	133	R3/8"	M12	22	190	8	122	160	17	22,5
63	4133.105.901																	
70	4133.105.902																	
80	4133.140.900	120000	273	220	230	3	12	75	172	R3/8"	M14	25	250	12	115	160	39	15
(85)	4133.140.901																	
90	4133.140.902																	
100	4133.160.900	200000	330	270	270	5	16	90	200	R3/8"	M18	38	300	12	110	160	64	15
110	4133.160.901																	
(115)	4133.160.902																	

1) Diameter printed in bold to be preferred. Diameter line without () corresponds to DIN 24334.

2) Please note recommendations on page 6.

3) Quantity of tapped holes and screws symmetrically distributed on ϕT

4) Max. oil volume required for releasing the clamping unit.

Safety Clamping Units

Application Examples

Positioning of Embroidery Frames

Ill. 4 shows the application example of the safety clamping unit as used in the precision machine industry. This Pfaff surface embroidery machine uses a linear positioner from SIG for the exact positioning of the embroidery frame; the RINGSPANN safety clamping unit then holds the embroidery frame precisely in its position, unaffected by any sudden or gradual fall of pressure in the

operating cylinder or load fluctuations at the embroidery frame.

Advantages

- Continuously variable positioning
- Exact holding of the position unaffected by a fall in pressure or fluctuation of the load
- Clamping without axial movement

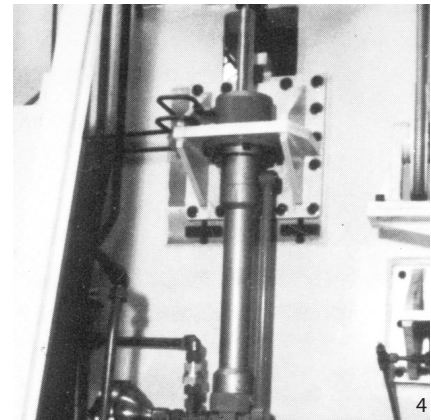

Securing of Scissor Lifting Platforms and Conveyor Plant

Ill. 5 shows an application of a safety clamping unit in a lifting platform made by Trepel for theatre installations. With the aid of these lifting platforms the height of the orchestra pit can be adjusted smoothly. The lifting mechanism is operated by hydraulic cylinders and the scissor principle.

Separate clamping cylinders which contain the RINGSPANN safety clamping unit are provided parallel to the lifting cylinders.

The set lifting height is held precisely at the desired level by the clamping cylinders without any sagging of the platform which could lead to raised edges on the stage. Apart from the

high precision of the safety clamping unit the safety aspect is a very important factor in this application.

Advantages

- Smooth adjustment of height

- No „sagging“ of the stage
- No system misalignment
- Safer than other protective systems against tube fractures and controls



Securing of Machining Heads on Machine Tools

The RINGSPANN safety clamping units are fixed onto the movable machining head and the clamping rods to the column. When the machine is switched off, the RINGSPANN safety clamping units have to hold the machining head in position. The feeding movement is carried out by an electro-hydraulic linear positioner. When the machine is switched on, the linear positioner is loaded with pressure before the RINGSPANN safety clamping units are released. In the „machine off“

position, the RINGSPANN safety clamping units lock first.

The machining head is held by the RINGSPANN safety clamping unit in its exact position. In this application, too, the safety aspect plays a major role.

Advantages

- Rigid and non-oscillating clamping
- Position is held independent of machining forces.

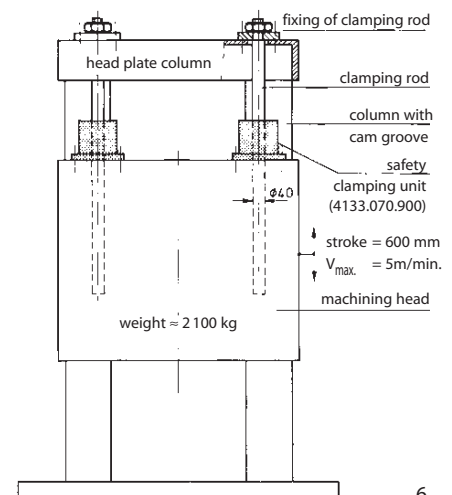

Safety Clamping Units

Application Examples

Securing of Pressure Rollers on Frame Saws

Ill. 7 shows a safety clamping unit flanged to a hydraulic cylinder which serves to continually hold down the pressure rollers on frame saws manufactured by Esterer, Altoetting.

When pressure loss occurs the safety clamping unit locks the piston rod and prevents the roller from being knocked upwards by the log being processed.

Advantages

- Securing of the pressure roller against sudden upward movement in case of pressure loss

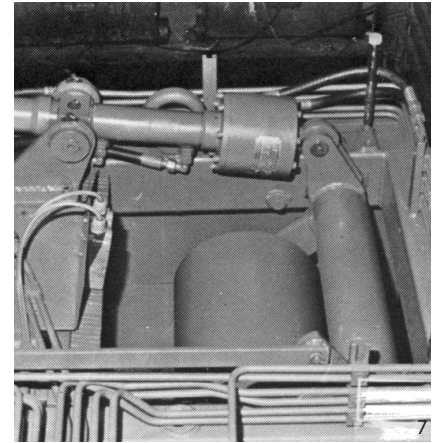

Positioning of Grinding Spindle Heads

Ill. 8 shows the application of a RINGSPANN safety clamping unit on a double-sided surface grinding machine manufactured by Meyer, Solingen, for the simultaneous machining of two surfaces on rough castings.

The grinding spindle heads are driven into the machining position by hydraulic cylinders where they are positioned precisely by the safety clamping units.

Advantages

- Rigid and non oscillating positioning
- Continuous feed of the grinding spindle heads

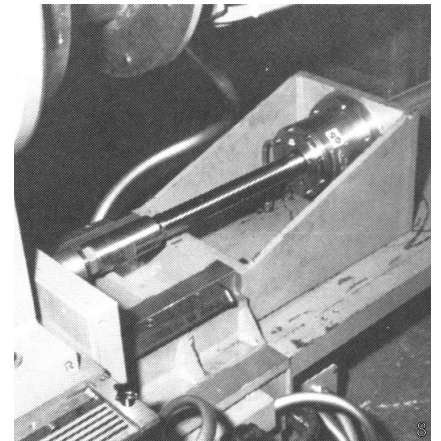

Presses and Machine Tool Industry

Securing of the upper parts of presses for tool changing.

Exact positioning of tool slides tool carriers, securing of feed installations.

Machine Manufacture

Positioning; height adjustment of winch installations and rollers; securing of adjusting drives/holding of polysolenoids piston rods and spacers.

Industrial Processing Engineering

Securing of hydraulic adjustments of extractors, furnace doors, bunker extractors, etc.

Fairground Installations

Securing of the main cylinder of lifting carousels against fracture and leakages. Holding of the position even during pressure loss. Securing of central operating cylinders; high-speed adjustment of longitudinal movements and supports.

Mechanical Conveying

Securing of elevating platforms; holding the preset position in case of hydraulic failure. Securing of operating cylinders for control and auxiliary apparatus; blocking brake on hydraulic cranes pressureless holding of support struts.

Mining

Securing of hydraulic lifting struts and working cylinders. For this the clamping unit can be hermetically sealed like a hydraulic cylinder. Underwater use possible!

Automotive Industry

Securing of hydraulic rear axle steering of heavy trailers. Securing of lifting cylinders in dump trucks.

Building Machines

Securing of working cylinders in dredgers, caterpillars, earth moving machines against tube fracture and leakage. Accident prevention.

Safety Clamping Units

Notes on Design and Installation

Effect of the Hydraulic Oil and the Clamping Period on the Holding Force

It is likely that after a certain operating time the piston rod will have been sprayed with the oil from the installation. Therefore the holding force is affected by the hydraulic oil being used.

The following applies to hydraulic oils H and HL, and to unalloyed oils:

$$\text{nominal holding force} = F_H$$

For hydraulic oils HLP and HL-XP this applies:

$$\text{nominal holding force} = 0.8 \times F_H$$

The nominal holding force thus calculated is reached when the clamping time t between removal of the release pressure and the application of the load does not fall below a minimum value of 5 sec. This applies to oils up to VG 100 with a minimum temperature of 20° C at the piston rod. If the clamping time is shorter, then the holding force transmissible depending on viscosity should be taken from the diagram.

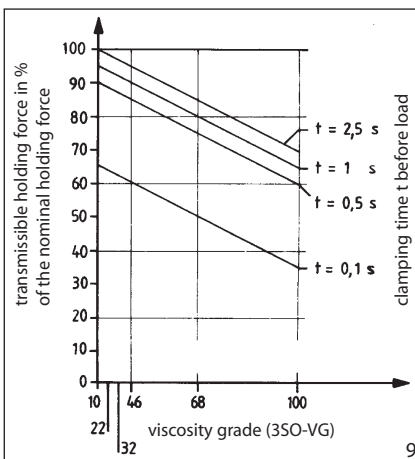

Holding force depending on oil viscosity and clamping period prior to load (temperature at the piston rod 20 °C)

If the hydraulic oil has a large amount of EP additives (eg V 6710, DH 46) the nominal holding force can fall below 80% of the table value. In such a case it would be necessary to carry out field tests. Solid lubricants like MoS₂, Graphite or Teflon should never be allowed near the clamping position.

Safety

$$\text{Safety } S = \frac{F}{F_a}$$

F = Holding force taking account of hydraulic oil and clamping duration (see above).

F_a = Maximum axial force including dynamic forces occurring during operation.

Positioning Accuracy

Clamping is effected without any axial movement between rod and clamping unit.

Under axial force F_H an axial displacement of up to 0.1 mm can result from the elastic distortion between the rod and the safety clamping unit. This displacement disappears again on release.

The Rod to be Clamped

The rod to be clamped should be made of material with a tensile strength of at least 600 N/mm² (e. g. C 45). It must be chromium plated or surfacehardened and ground. Its diameter must be designed with fit f7 and a peak-to-valley height of $R_t = 5 \mu\text{m}$. With normal use the maximum pressure at the point of clamping between the piston rod and the clamping unit is 150 N/mm².

Sealing and Centering

On the cover side the clamping unit has a wiper seal for the rod. A seal against waste oil should be provided by the customer on the side of the machine or cylinder where the clamping connection is to be located. In order to ensure a lasting and troublefree operation and to avoid damage to the rod to be clamped, the exact concentricity of the bar towards the machine centering must be observed. (Max. circular runout 0.04 mm).

Release to facilitate Mounting

To insert the rod hydraulic pressure is applied on the clamping unit. If at this time the hydraulic installation is not yet operational, a hand pump may be used instead.

Special Types

If special types with a higher positioning accuracy, higher holding forces or lower release pressures are required, please let us have your enquiries together with the completed questionnaire on the next page.

Questionnaire for RINGSPANN Safety Clamping Units

please photocopy

Company:	Department:
Address:	Name:
.....	Enquiry no.:
Telephone:	Date:
Telefax:	e-mail:

1. Load

In one direction only: max. _____ N

In both directions: \longrightarrow max. _____ N

\longleftarrow max. _____ N

Required safety factor: The holding force of the clamping unit should be approx. ____ % higher than the maximum load.

Static clamping: The Clamping rod is standing still during the clamping process.

If not:

Dynamic clamping: The clamping rod is moving within the clamping unit while clamping. Speed _____ mm/s.

The clamping position must be held absolutely exact and fixed. (Permissible tolerance mm).

If not:

Max. permissible elasticity in the clamping rod while under load _____ mm.

2. Clamping rod diameter

12_{f7} 14_{f7} 16_{f7} 20_{f7} 25_{f7} 32_{f7} 40_{f7} 50_{f7} 63_{f7} 80_{f7} 100_{f7}

None of the standard diameters above is applicable. The rod diameter must be _____ mm.

3. Arrangement

Horizontal Vertical

A sketch of the illustration Seal for connecting flange and rod is/not provided.

4. Release Pressure To release the clamping unit oil pressure of _____ to _____ bar is available.

5. Particular Influences

Sideload onto the rod Acid vapours

Intensive dirt accumulation The clamping unit is to be fitted to a hydraulic cylinder

Seawater

6. Durability Number of expected clampings per year _____

7. Requirement _____ units (one off application) _____ units/month _____ units/year

8. Other (e.g. previous solution)



Freewheels

Backstops

Automatic protection against reverse running of conveyor belts, elevators, pumps and fans.

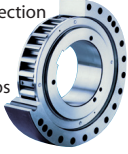

Catalogue 88

Overrunning Clutches

Automatic engaging and disengaging of drives.



Catalogue 80

Indexing Freewheels

For gradual feed of materials.



Catalogue 80

Housing Freewheels

Automatic engaging and disengaging for multi-motor drives for installations with continuous operation.

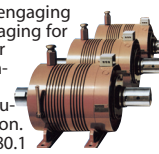

Catalogue 80.1

Freewheel Elements

Cage Freewheels, Sprag Sets and Freewheel Chains.



Catalogue 89

Brakes

Industrial Disc Brakes

Manually actuated – manually released.



Catalogue 46

Industrial Disc Brakes

Spring actuated – pneumatically, hydraulically or manually released.

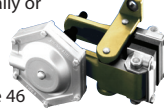

Catalogue 46

Industrial Disc Brakes

Spring actuated – electromagnetically released.

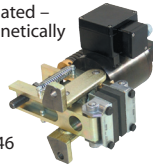

Catalogue 46

Industrial Disc Brakes

Pneumatically actuated – spring released.



Catalogue 46

Industrial Disc Brakes

Hydraulically actuated – spring released.

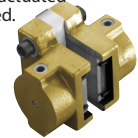

Catalogue 46

Torque and Force Limiters

Torque Limiters with Screw Face

Reliable overload protection for tough operating conditions.



Catalogue 45

Torque Limiters with Rollers

With double or single Rollers. Through ratcheting or disengaging, also for 360° synchronous running.



Catalogue 45

Torque Limiters with Balls

Reliable overload protection with maximum response accuracy. Also backlash free.



Catalogue 45

Torque Limiters with Friction Linings

RIMOSTAT Torque Limiter for constant torque. Belleville Spring Torque Limiter for simple release.

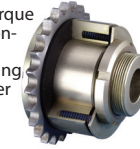

Catalogue 45

Force Limiters

Reliable axial overload protection in piston rods.

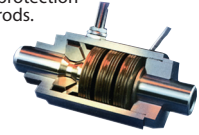

Catalogue 49

Couplings and Clamping Clutches

Flexible Couplings

Large, allowed radial and angular misalignments. Minimum resiliency.



Catalogue 44

Flange-Couplings

Rigid, easily removable shaft coupling with no clearance cone clamping elements.



E04.020

Clamping Clutches

For the automatic coupling of rolls. Fast, safe and free from slipping connection.



E01.023

Safety Clamping Units pneumatically released

For secure and precise positioning of piston rods.

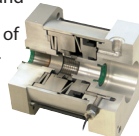

E01.023

Safety Clamping Units hydraulically released

For secure and precise positioning of piston rods.

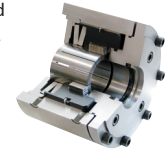

Catalogue 32

Shaft-Hub-Connections

Two-part Shrink Discs

External clamping connection. Advantages: Simple, secure mounting even without torque wrench.

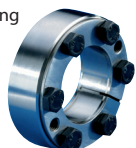

Catalogue 31.1

Three-part Shrink Discs

External clamping connection for the fastening of hollow shafts on solid shafts

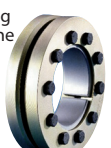

Catalogue 31

Cone Clamping Elements

For shaft-hub connections. High torques with small dimensions.

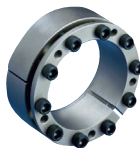

Catalogue 31

Star and Clamping Discs

Ideal for shaft-hub-connection for frequent release.



Catalogue 30

Star Spring Washers

Axial spring element for preloading of ball bearings.



Catalogue 20

Precision Clamping Fixtures

Standard Parts for Clamping Fixtures

The RINGSPANN-System for the manufacture of your own precision clamping fixtures.

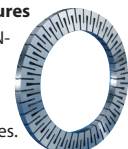

Catalogue 14

Standard Clamping Fixtures

Standard program in high precision, ready manufactured chucks and mandrels.



Special Clamping Fixtures

Custom made solutions for specific clamping problems.



Collet Mandrels

Universal, cost effective standard series. Fast collet change to other clamping diameters.



Catalogue 15

Hydraulic Expanding Clamping Tools

Mandrels and chucks with high concentricity. Clamping several workpieces in one process possible.



Catalogue 16

