

SHRINK DISCS RLK 608

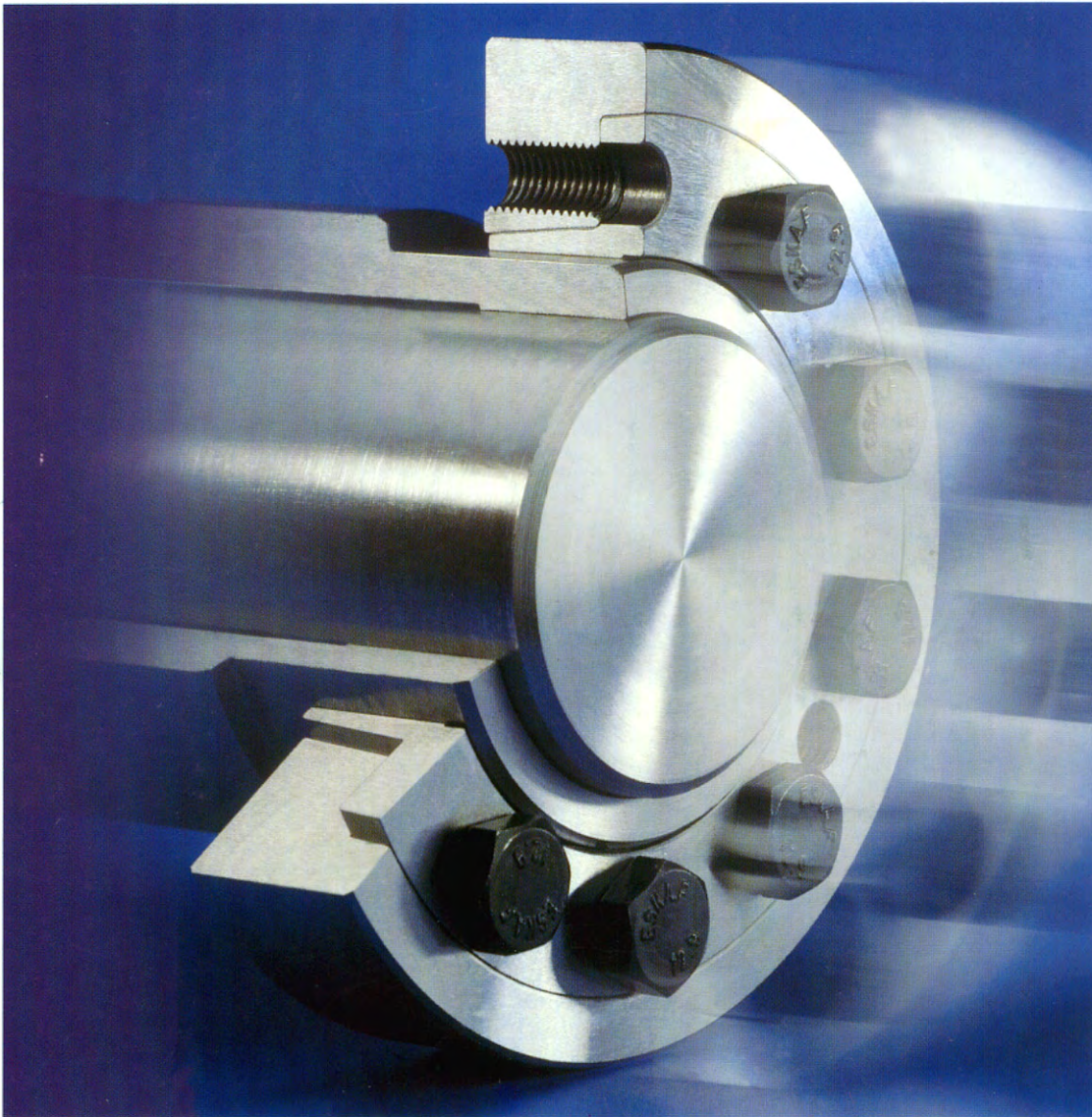

31.1

RINGSPANN® Registered Trade Mark of RINGSPANN GmbH, Bad Homburg



Shrink Discs RLK 608

A Gripping Experience

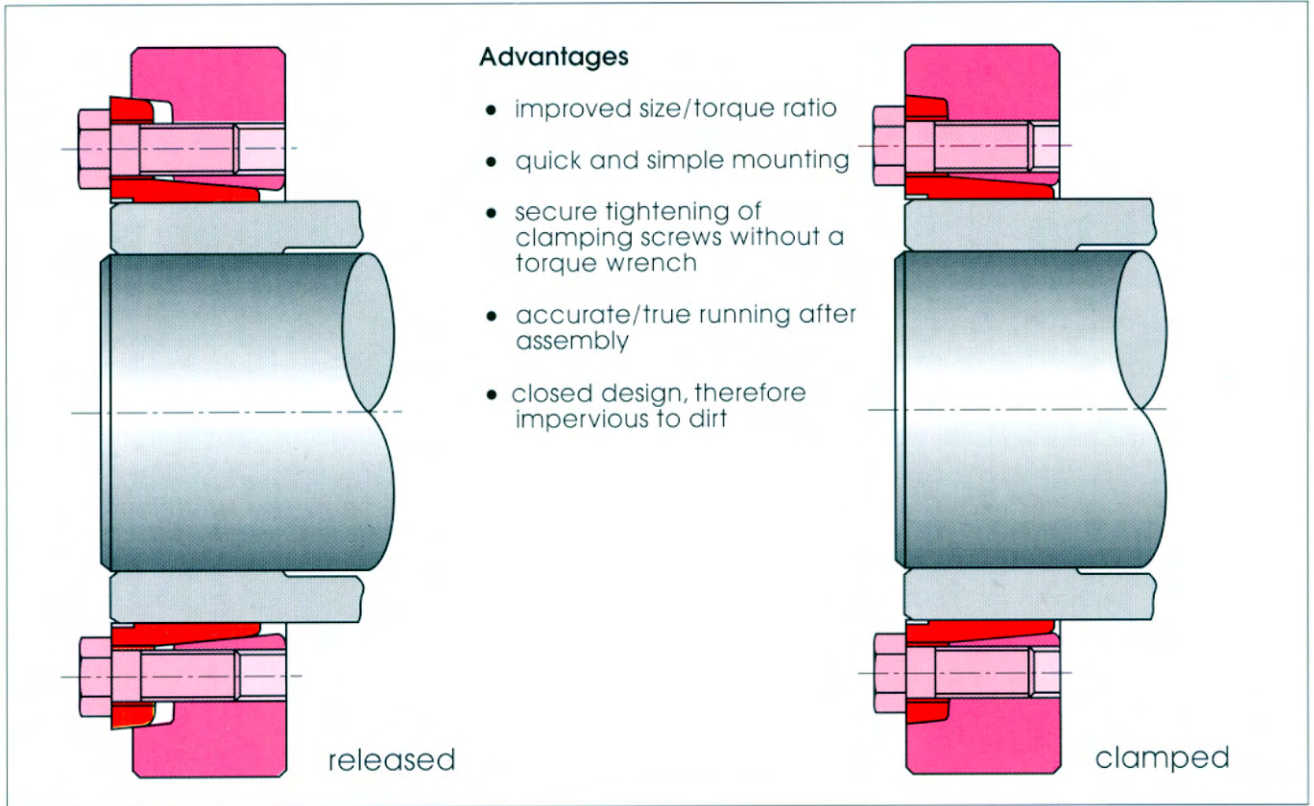

For over 50 years the name RINGSPANN has stood for the successful application of releasable, form-locking connections of shafts and hubs.

The well known cone clamping elements by RINGSPANN are used as an inner clamping connection in many types of application in the machine industry for fastening gear wheels, chain wheels, belt pulleys, belt conveyor drums etc. Using shrink discs as an outer clamping connection facilitates playfree fastening of hollow shafts to shaft ends.

Once again, RINGSPANN has extended its product range with a modern and particularly economical clamping element:

Shrink Disc RLK 608

This allows for transmission of high torques, thereby providing maximum safety for the user. The greatest advantage of the new shrink disc RLK 608 lies in the speed and ease of mounting. It is simply a matter of tightening the clamping screws just enough until the screw-side faces of the outer and inner part are in line. This will guarantee the catalogue torque. There is no need for a torque wrench.

Based on up to date production processes and supported by expert advice, RINGSPANN offers technically and economically optimum products and problem solving in all areas of power transmission and clamping technology.

Shrink Discs RLK 608

Dimensions and technical details

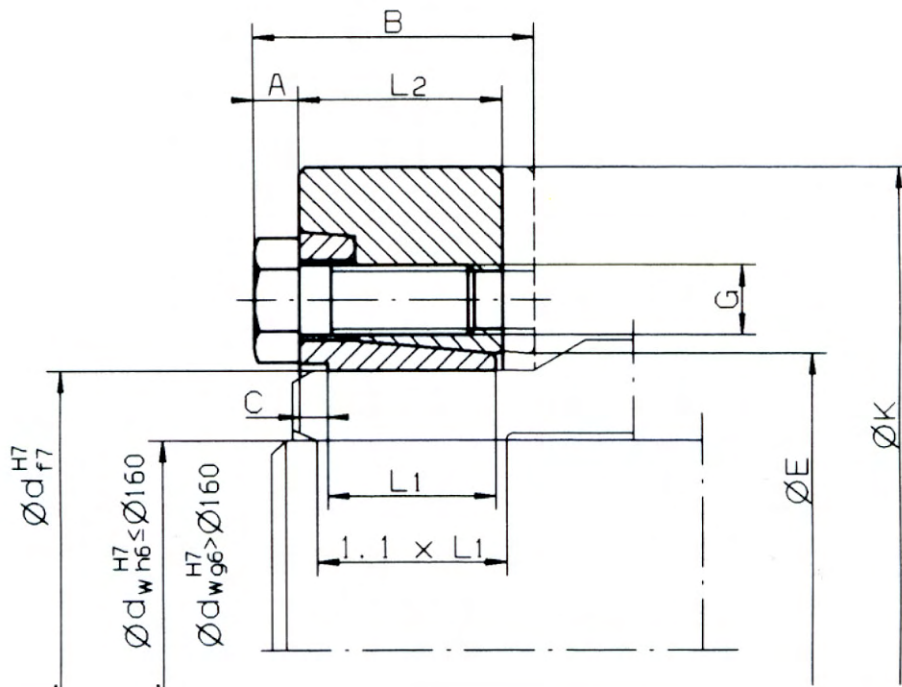

- Torques:** The table lists the peak torques M which can be transmitted via the shrink disc connection when neither axial forces nor bending moments are affecting the point of connection.
- Axial Forces:** If axial forces F_{ax} are present then the torque which can be transmitted in the connection is reduced, i.e. M_{red} which is calculated as follows:
$$M_{red} = \sqrt{M^2 - (d_w \cdot F_{ax} / 2000)^2} \text{ [Nm]}$$
The following applies in this: M [Nm], d_w [mm] according to the table, F_{ax} [N] are occurring axial forces.
- Bending Moments:** If, apart from the torque M and possibly axial force F_{ax} , there are additional bending moments in the connection, the table torque is reduced. Please contact us for clarification.
- Surfaces:** The average peak-to-valley height on the pressure surfaces of shaft and hollow shaft should be $R_z \leq 15 \mu\text{m}$.
- Friction value:** The table values are based on a friction value of $\mu = 0,15$ between shaft and hollow shaft.
- Shaft diameter:** The shaft diameters d_w in the table are examples. We shall be pleased to provide you with calculations of torques and axial forces for other shaft diameters.
- Material of hollow shaft:** The material of the hollow shaft should have a minimum yield point of $R_e \geq 360 \text{ N/mm}^2$. The torques and axial forces in the table are based on an E-modulus of elasticity of 206.000 N/mm^2 of shaft and hollow shaft. We shall be pleased to provide calculations of the stresses at the critical points in the shaft and hollow shaft.

Shrink Discs RLK 608

Dimensions, transmissible torques and axial forces

Size RLK 608-"d"		dimensions								torques and axial forces depending on shaft diameter								
d mm	article no. 4200.	A mm	B mm	C mm	E mm	G mm	K mm	L1 mm	L2 mm	dw mm	M Nm	F kN	dw mm	M Nm	F kN	dw mm	M Nm	F kN
30	030.801	4,0	25	2	32	M 6	60	17	19	24	300	25	25	350	28	26	400	31
36	036.801	5,3	28	2	38	M 8	72	18	20	27	610	45	30	750	50	33	910	55
44	044.801	5,3	30	2	47	M 8	80	20	22	34	760	45	35	850	49	37	920	50
50	050.801	5,3	33	2	53	M 8	90	22	24	38	1650	87	40	1850	93	42	2100	100
55	055.801	5,3	35	3	58	M 8	100	23	26	42	1750	83	45	2200	98	48	2600	108
62	062.801	5,3	35	3	66	M 8	110	23	26	48	2400	100	50	2600	104	52	3000	115
68	068.801	5,3	35	3	72	M 8	115	23	26	50	2500	100	55	3300	120	60	4100	137
75	075.801	6,4	39	3	84	M10	141	25	29	55	4600	167	60	5700	190	65	6900	212
80	080.801	6,4	39	3	84	M10	141	25	29	60	4600	153	65	5700	175	70	6900	197
90	090.801	6,4	45	4	94	M10	155	30	35	65	6500	200	70	7800	223	75	9200	245
100	100.801	6,4	51	5	104	M10	170	34	40	70	8100	231	75	9700	259	80	11300	283
110	110.801	7,5	59	6	114	M12	185	39	45	80	13900	348	85	16100	379	90	18600	413
120	120.801	7,5	63	6	132	M12	200	42	49	85	15000	353	90	17200	382	95	19800	417
125	125.801	7,5	63	6	132	M12	215	42	49	90	17900	398	95	20500	432	100	23300	466
130	130.801	7,5	68	6	139	M12	230	46	49	95	22500	474	100	25500	510	110	32000	582
140	140.801	8,8	71	6	144	M14	230	46	53	100	25300	506	105	28000	533	115	35600	619
150	150.801	8,8	74	6	159	M14	263	50	57	110	33900	616	115	37600	654	125	45000	720
155	155.801	8,8	74	6	159	M14	263	50	57	110	33900	616	115	37600	654	125	45000	720
160	160.801	10	81	6	169	M16	290	56	63	120	48000	800	125	53000	848	135	58000	859
165	165.801	10	82	6	169	M16	290	56	63	120	48000	800	125	53000	848	135	58000	859
170	170.801	10	83	6	179	M16	300	56	63	130	58500	900	135	64000	948	145	70000	966
175	175.801	10	83	6	179	M16	300	56	63	130	58500	900	135	64000	948	140	70000	1000
180	180.801	10	98	7	191	M16	320	71	79	140	88500	1264	145	96000	1324	155	110000	1419
185	185.801	10	100	7	191	M16	320	71	79	140	88500	1264	145	96000	1324	155	110000	1419
190	190.801	10	103	7	206	M16	340	74	82	150	105000	1400	155	113000	1458	165	121500	1473
195	195.801	10	104	7	206	M16	340	74	82	150	105000	1400	155	113000	1458	165	121500	1473
200	200.801	10	104	7	206	M16	340	74	82	150	105000	1400	155	113000	1458	165	121500	1473
220	220.801	12	120	7	228	M20	370	87	95	160	142000	1775	170	153000	1800	180	169000	1878
240	240.801	12	126	7	248	M20	405	92	100	170	166000	1953	180	189000	2100	200	221000	2135
260	260.801	12	126	8	268	M20	430	102	110	190	233000	2453	200	262000	2620	220	299000	2668
280	280.801	12	151	8	288	M20	460	114	123	210	307000	2924	220	342000	3109	240	378500	3154
300	300.801	15	164	8	308	M24	485	122	131	220	365000	3318	230	403500	3509	250	444500	3556
320	320.801	15	165	8	328	M24	520	122	131	240	444500	3704	250	488500	3908	270	533500	3952
340	340.801	15	177	8	348	M24	570	134	143	250	537000	4296	260	586500	4512	280	638000	4557
360	360.801	15	185	8	368	M24	590	140	149	270	687500	5093	280	744500	5318	300	805000	5367
390	390.801	17	193	8	398	M27	650	144	153	290	859000	5924	300	926000	6173	320	996500	6228
420	420.801	17	214	8	428	M27	670	164	173	320	1066000	6663	330	1142000	6921	350	1220000	6971
440	440.801	17	223	8	448	M27	720	172	181	340	1333500	7844	350	1421000	8120	370	1512500	8176

Example for ordering: Shrink disc RLK 608-68, article no. 4200.068.801

Quick and cost effective mounting

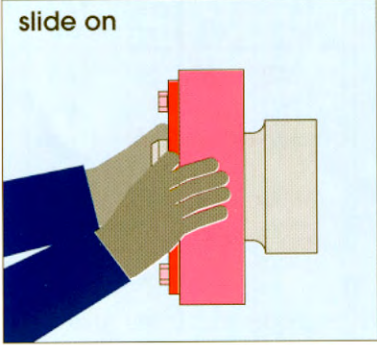

slide on

Slide the shrink disc in unclamped state onto the hollow shaft and then slide the shaft and hollow shaft into each other.

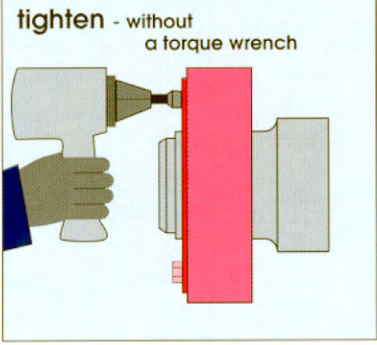

tighten - without a torque wrench

Tighten the clamping screws by hand whilst aligning the shrink disc. Tighten the clamping screws one by one in a clockwise direction (not crosswise) – see installation instructions – until.....

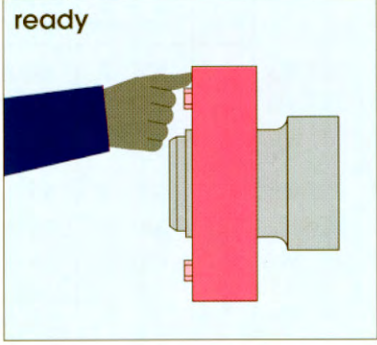

ready

...the screw-side faces of the outer ring and the inner ring are in line.

Example of lower mounting costs with an RLK 608-125*

procedure		normal mounting with torque wrench		mounting RLK 608	
		time (hrs.)	cost £	time (hrs.)	cost £
010	slide shrink disc onto hollow shaft	0,025	0,64	0,025	0,64
020	align shrink disc*	0,083	2,12	required	
030	set torque wrench	contained in 040		required	
040	evenly tighten 12 clamping screws M12 (calculation based on 10 rounds)	0,170	4,34	0,050	1,28
050	check the prescribed tightening torque of screws	0,016	0,41	required	
Total cost of mounting		0,294	7,51	0,075	1,92
saving of		5,59			

*Comparison with a 3-part shrink disc of the same size

Your Expert on Cone Clamping Elements

RLK 200

The classic standard type. Available in a choice of 50 sizes for shaft diameters of 20 to 900 mm.

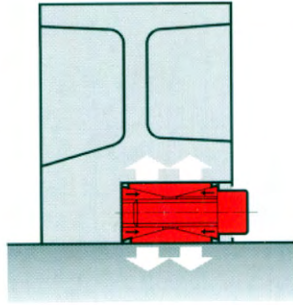

RLK 110

self-centering

This clamping element is particularly suited to clamping thin-walled hubs. The long clamping length guarantees true centering of the hub. The lateral location ring secures the axial position of the hub; the set position does not alter during clamping. Available for shaft diameters from 6 to 130 mm.

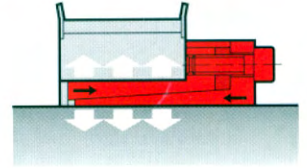

RLK 400 + RLK 402

self-centering

The clamping element for heavy applications. Of particular advantage are the large clamping areas of the inner and outer rings, resulting in relatively minor surface pressures on the shaft and hub even at high torques. The setting of the axial position does not change during clamping. Available for shaft diameters of 45 to 600 mm.

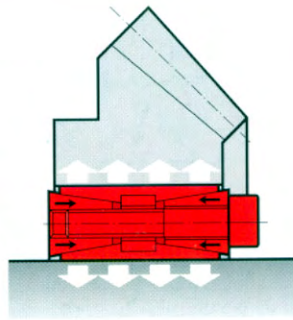

RLK 250

self-centering

A clamping element which is very easy to mount; all you have to do is tighten the keywayed locking nut. Can be made to space-saving dimensions axially as tightening is radially with a C-spanner. Available for shaft diameters of 15 to 70 mm.

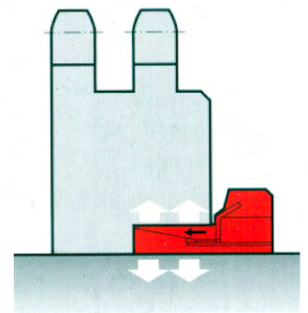

RLK 131 + RLK 133

self-centering

A universal clamping element for standard applications. The long clamping length guarantees true centering of the hub. The stop ring secures the axial position of the hub; the set position does not alter during clamping. Available for shaft diameters of 20 to 200 mm.

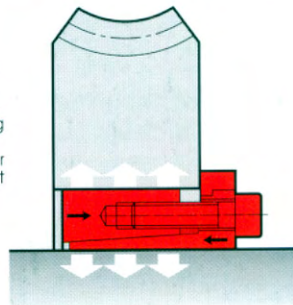

RLK 300

The clamping element for the specific clamping connection. Tightening is via thrust rings or pressure flanges. Minimum radial installation dimensions offer particular advantages. Available for shaft diameters of 10 to 540 mm.

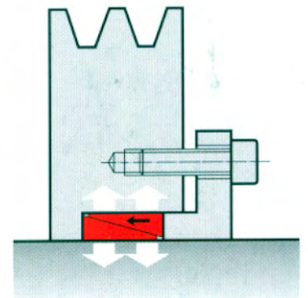

RLK 130 + RLK 132

self-centering

Same type as RLK 131 but without the lateral stop ring. The transmissible torques are 60% higher because only the cone surfaces slide during tightening. Available for shaft diameters of 20 to 200 mm.

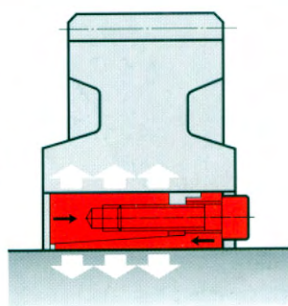

RLK 603

Shrink Discs

The standard outer clamping connection for the play-free fastening of hollow shafts to shaft ends. Available for shaft diameters from 14 to 480 mm.

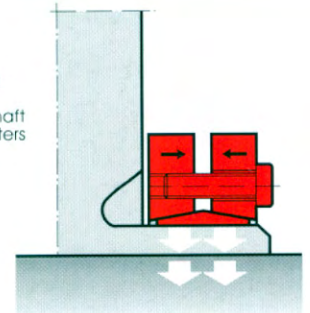

Please request our catalogue No. 31 for further information



RINGSPANN GmbH

Schaberweg 30-34
61348 Bad Homburg

Tel. 061 72/275-0
Fax 061 72/275275

Internet: <http://www.ringspann.com>
e-mail: mailbox@ringspann.com