

POWERTORK®

GEAR COUPLINGS

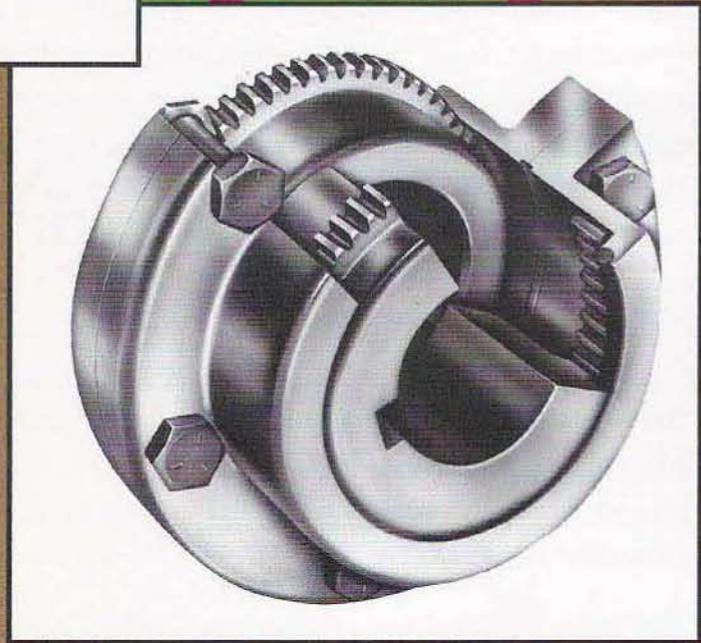
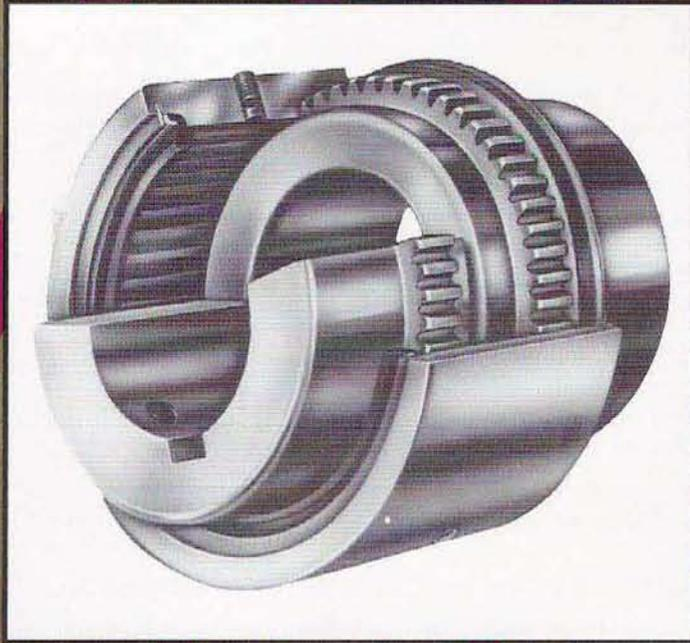

SYSTEM
COMPONENTS, INC.

1635 Stieve Drive
South Haven, Michigan 49090
Phone 269-637-2191 FAX 269-637-8377

INDUSTRIAL MAGZA
DIST. AUTORIZADO

MEX (55) 53 63 23 31

QRO (442) 1 95 72 60

MTY (81) 83 54 10 18

ventas@industrialmagza.com

POWERTORK®

Continuous Sleeve Type Gear Couplings

The Series "S" Continuous Sleeve Type Coupling incorporates a one piece splined sleeve and two hubs with TRIPLE CROWNED gear teeth.

Specified by major O.E.M.'s and industrial users, Continuous Sleeve Type couplings designed and manufactured by System Components, Inc. are installed on a wide range of drive applications.

A strong rugged coupling that meets demanding performance and quality requirements making POWERTORK® a natural for industrial power transmission applications. Here are some of the key Features and Advantages.

Features

- o Compact, Lightweight
- o High Misalignment Capability
- o Large Inventory of Stock Couplings
- o Larger Sizes Available
- o Other Types Available
- o Ease of Lubrication

Advantages

Much smaller in diameter and lighter weight, as compared to flange couplings.

Up to $\pm 3^\circ$ Angular misalignment.

Full Flex and Flex Rigid stock available in sizes 6-S through 45-S accommodating bore sizes to 5 3/4".

All Coupling configurations available to suit customer requirements.

Includes mill motor, cut-out and floating shaft couplings. See page 30.

Facilitated by two lubrication pipe plugs 180° apart in the sleeve



SERIES "F" - COUPLING INSTALLATION AND MAINTENANCE INSTRUCTIONS.

INSTALLATION

- 1) Make sure that all the proper coupling parts, keys, etc. are on hand.
- 2) Make sure that the prime mover is disconnected from the power source so that it cannot be started accidentally during installation.
- 3) Remove dirt and burrs from the shafts and coat with a suitable anti-galling lubricant.
- 4) Pack sleeve teeth and coat seals with coupling grease and insert coupling seals in the grooves. (See listing on back of sheet for recommended greases.)
- 5) Insert keys in shaft keyways. Keys should have a snug fit to the sides of the keyways with slight clearance top to bottom.
- 6) Place sleeves over the shafts with the flanges facing each other.
- 7) Mount hubs on the shafts.
- 8) Align the shafts by placing the machines in their approximate positions. (Refer to Table No. 1 on back of sheet for the correct shaft separation.) Best coupling performance is obtained when the alignment is checked with dial indicators.

NOTE: Always rotate the hub on which the indicator is mounted.



Figure 1.

Figure 2.

A. Angular Alignment.

Check by mounting indicator on the body of one hub and placing the pointer on the end face of the other hub. (See Figure 1.) Adjust machines until the best possible alignment is obtained. As an alternate method, insert a feeler gage between the hubs at four points approximately 90° apart and adjust the machines. (See Figure 2.)



Figure 3.

Figure 4.

B. Parallel Alignment.

Mount the indicator on the body of one hub and place the pointer on the body of the other hub. (See Figure 3.) Adjust machines until the indicator reading is the same at four points approximately 90° apart. As an alternate method, place a straight edge across one hub body and adjust the machines until the straight edge rests squarely on the other hub body. (See Figure 4.) This should be done at 90° intervals around the hub.

Securely tighten foundation bolts and recheck the alignment. Adjust the machines again, if necessary.

- 9) **Assemble Coupling.**
Coat hub teeth and body with coupling grease. Make sure flanges are free of dirt and burrs. Slide sleeves in until they mesh with hub teeth. Lube holes should be at about 90° on the opposite sleeve. Insert the gasket and then bolt sleeves together, tighten to torques shown in Table No. 1. Use only the bolts furnished in the accessory kit, as these bolts have a special body diameter to assure proper alignment.
- 10) **Lubricate.**
Remove pipe plugs from one flange with the position of the pipe plugs approximately 45° above and below horizontal and pump grease into the hole that is above horizontal until the grease flows from the hole that is below horizontal. Replace the pipe plugs making sure they are tightened firmly.

Note: 1) Do not attempt to pump grease into the coupling by removing only one pipe plug.

2) Do not fill the interior of spacer. The correct amount of coupling grease is shown in Table No. 1. One-half of this amount should be put into each coupling sleeve.

CAUTION: INSTALL GUARDS AROUND COUPLING ACCORDING TO LOCAL AND NATIONAL CODES.



OTHER COUPLINGS AVAILABLE

SERIES "F"

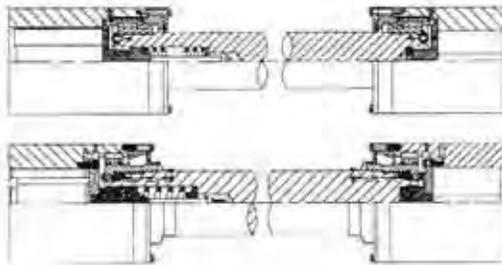

o Spindle Couplings

Spindle couplings are shaft connections for drives requiring high offset misalignment and other special capabilities for replacing universal joints, wobblers, and floating shaft arrangements. Spindle couplings are used where frequent roll removal is required.

o Spindle Repair and Overhaul

Complete repair capabilities for repair of Roll and Pinion sleeves, shafts and other components. Replacement or repair to components made by any manufacturer.

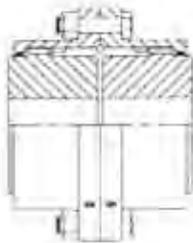

o High Speed Couplings

High speed gear couplings are generally used in applications that require higher speeds than standard Series "F" type couplings. The basic difference includes steel pilot rings, fitted gears and matched-marked (serial numbered) assemblies, couplings are dynamically balanced. Fasteners are weigh balanced. Couplings can be either grease lubricated or continuous oil lubricated.

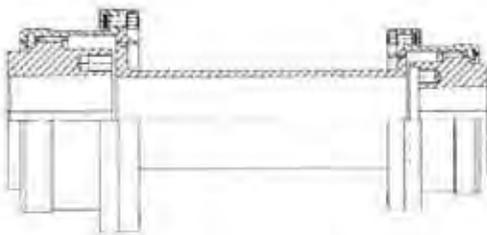

o High Performance and Dynamically Balanced Coupling

These couplings are extensively used in high speed applications such as gas turbines, compressors, blowers and other similar applications. The couplings are manufactured from heat treated alloy steel. They are balanced to high standards and match marked to ensure smooth operation. The couplings are available in both packed lube and continuous lube design.

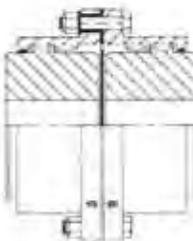

o Insulated Coupling

The two flex-halves are electrically insulated from each other to prevent the flow of stray shaft currents from one machine to another. These couplings are not intended to withstand high potentials, short circuits or static changes. They will protect against the pitting of precision bearings and shafting, which occurs in generator exciter drives.

Profiling POWERTORK® Series F and Series S Gear Couplings

POWERTORK® Series F flange type gear couplings are available in Full Flex, Flex Rigid, Rigid Rigid and other designs. A large inventory of stock is carried for sizes 1-F through 10-F accommodating bore sizes up to 14½". They are also available in larger sizes up to 30-F accommodating bore sizes up to 46".

POWERTORK® Series S continuous sleeve type gear couplings incorporate a one-piece splined sleeve and two hubs with triple-crowned gear teeth. These products are much smaller in diameter and lighter than flange couplings.

The significant differences between POWERTORK® couplings and the competition are:

- Manufactured from higher quality steel.
- Higher grade bolts (grade 8 vs grade 5).
- Manufactured to tighter critical and dimensional standards.
- Manufactured from forgings for increased strength, durability and longer life.
- Meets industry standards for interchangeability with competitive brands.
- Excellent delivery on specials.
- Standard products are typically priced significantly below competition.



OTHER COUPLINGS AVAILABLE

SERIES "F"

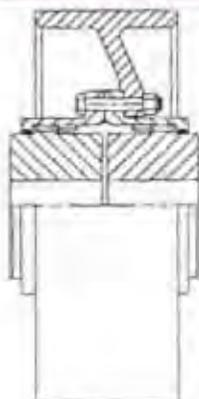

o Brakewheel Types

Brakewheel couplings accommodate misalignment between connected equipment and eliminate the need for double shaft extensions on motors and gear units for applications requiring shoe-type brakes.



o Double Engagement

Double engagement couplings are used in four-bearing systems to compensate for the angular, offset and axial (end float) misalignment that usually exists. Ideal for all horizontal, close applications including fans, overhead cranes, conveyors, steel and paper mill equipment.

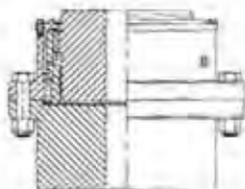

o Vertical Double Engagement

Vertical double engagement couplings are standard horizontal double engagement gear couplings with hubs and sleeves remachined to receive the sleeve centering components. Vertical applications require the addition of a sleeve centering assembly to avoid back tooth contact at the top of the mesh. Refer to the Factory for applications where thrust loads between shafts are to be transmitted by the coupling.

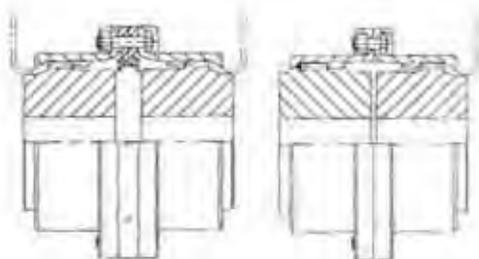

o Continuously Lubricated

- with center discharge ring
- with discharge one end.

Continuously lubricated couplings are often preferred for dynamically balanced couplings used in high speed applications. This style of coupling is commonly used where continuous operation is required for longer periods than regular maintenance intervals.



MAGZA
DIST. AUTORIZADO

MEX (55) 53 63 23 31 MTY (81) 83 54 10 18
QRO (442) 1 95 72 60 ventas@industrialmagza.com

OTHER COUPLINGS AVAILABLE

DS119 REV. 01

SERIES "F"

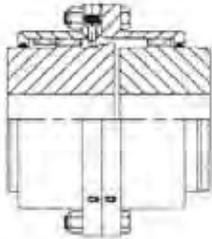

o Cutout Couplings.

Pairs of cutout couplings are commonly used on dual drives, having an auxiliary prime mover (usually an engine or turbine) for emergency use. The changeover is performed at standstill by disengaging the coupling on the primary driver and engaging the coupling on the standby drive. With one cutout coupling, a unidirectional drive can be disconnected to permit partial system reversal. The first unit of a tandem drive can be similarly cut out.

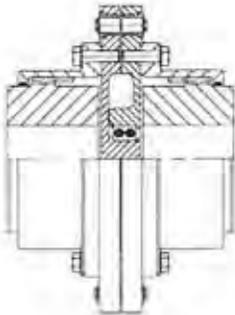

o Overload Release Types With Shear Pin

Easily replaceable shear pins, housed in hardened steel bushings. Pins are intended to shear at a pre-determined maximum load range, thereby disconnecting the driver and driven shafts. They are especially suited to protect equipment when jams occur.

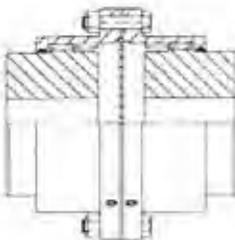

o Slide Couplings

Slide couplings are an inexpensive exposed bolt coupling with varying slide capacities. They are commonly used on applications such as disc refiners in the pulp and paper industry, bridge drives on overhead traveling cranes and where the magnitude of thermal shaft growth precludes use of standard Series "F" couplings.

o Short Slide

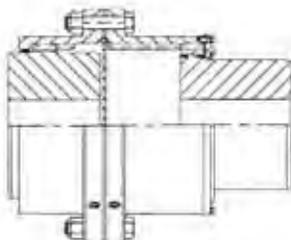

o Medium Slide and Long Slide Types



MEX (55) 53 63 23 31 MTY (81) 83 54 10 18
QRO (442) 1 95 72 60 ventas@industrialmagza.com

POWERTORK®

DATA SHEET DS114 REV. 03

Series "F" Flange Details.

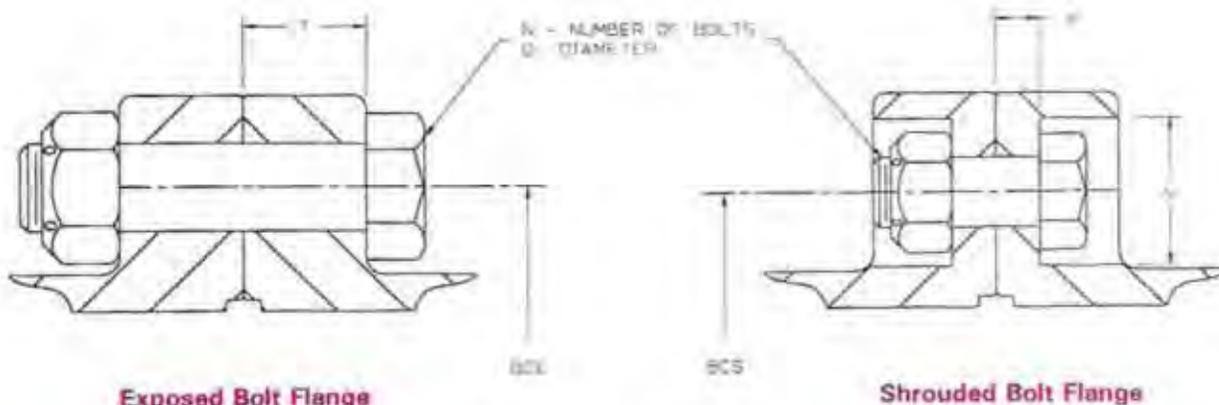

Exposed Bolt Flange

Shrouded Bolt Flange

Series F	Size	1	1½	2	2½	3	3½	4	4½	5	5½	6	7
	T	.56	.75	.75	.88	.88	1.13	1.13	1.13	1.50	.94	1.00	1.13
Exposed Bolt	BCE	3.750	4.813	5.875	7.125	8.125	9.500	11.000	12.000	13.500	14.500	15.750	18.250
	N	6	8	6	6	8	8	8	10	8	14	14	16
	D	1/4"	3/8"	1/2"	5/8"	5/8"	3/4"	3/4"	3/4"	7/8"	7/8"	7/8"	1"
Shrouded Bolt	BCS	3.750	4.813	5.813	7.000	8.000	9.281	10.625	11.750	13.188	-	-	-
	N	6	8	10	10	12	12	14	14	14	-	-	-
	D	1/4"	3/8"	3/8"	1/2"	1/2"	5/8"	5/8"	5/8"	3/4"	-	-	-
	V	.64	.88	.88	1.06	1.06	1.31	1.31	1.31	1.56	-	-	-
	W	.25	.25	.25	.31	.31	.38	.38	.38	.56	-	-	-

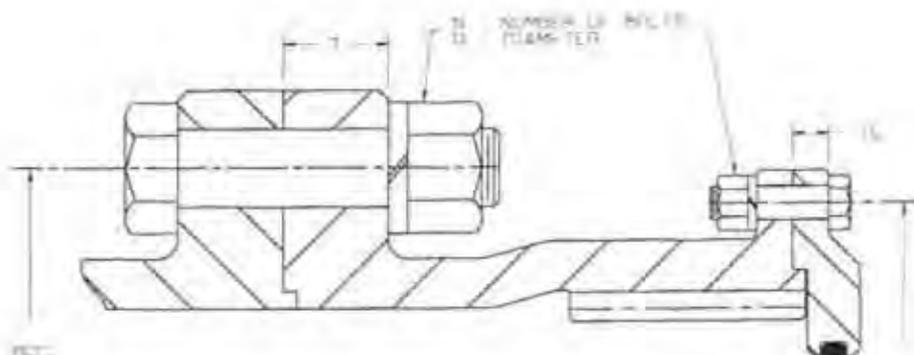

Series F	Size	8	9	10	11	12	13	14	15	16	18	20	22	24	26	28	30
Center Flange	T	1.31	1.44	1.75	2.00	2.13	2.19	2.25	2.25	2.38	2.50	2.75	2.88	3.00	3.13	3.25	3.38
	BCC	20.750	23.250	25.250	27.500	30.000	32.250	34.500	36.75	39.000	43.250	48.750	53.500	58.250	62.500	67.250	71.500
	N	16	18	18	18	18	18	18	18	20	20	22	22	22	22	24	22
	D	1-1/8"	1-1/4"	1-3/8"	1-1/2"	1-1/2"	1-5/8"	1-3/4"	1-3/4"	2"	2"	2-1/4"	2-1/2"	2-3/4"	2-3/4"	3"	3"
End Ring Flange	TE	.56	.69	.69	.69	.81	.81	.81	.88	.88	.88	1.25	1.25	1.38	1.38	1.50	1.50
	BCR	19.375	21.750	23.875	26.063	28.313	30.500	32.625	35.000	37.125	41.375	46.250	50.750	55.000	59.250	63.688	68.188
	N	10	12	12	12	12	12	14	14	14	14	16	16	16	18	16	18
	D	1/2"	5/8"	5/8"	5/8"	3/4"	3/4"	3/4"	7/8"	7/8"	7/8"	1"	1"	1-1/8"	1-1/8"	1-1/4"	1-1/4"



INDUSTRIAL MAGZA

MEX (55) 53 63 23 31 MTY (81) 83 54 10 18

DIST. AUTORIZADO

QRO (442) 1 95 72 60 ventas@industrialmagza.com

POWERTORK®

DATA SHEET DS142 REV. 00

Series "F" Full Flex And Flex Rigid Couplings For TAPER-LOCK® Bushings

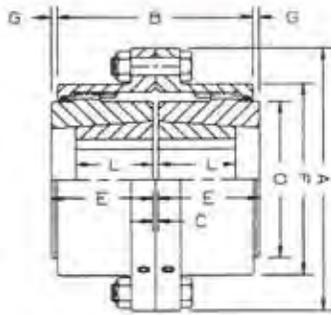

**Full Flex - Standard Mount
Inboard - Inboard**

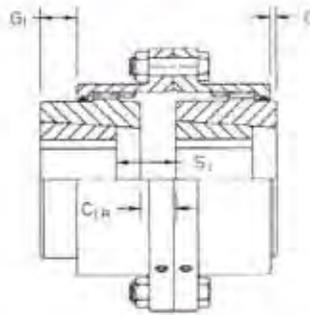

**Full Flex - One Hub Reversed
Outboard - Inboard**

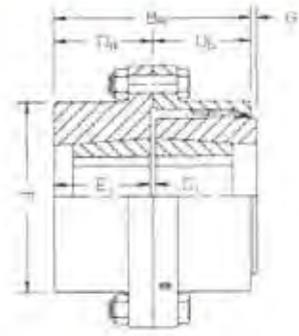

**Flex Rigid - Standard Mount
Inboard - Inboard**

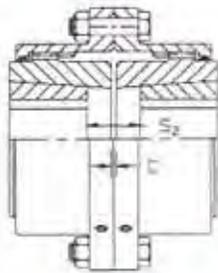

**Full Flex - Standard Mount
Outboard - Outboard**

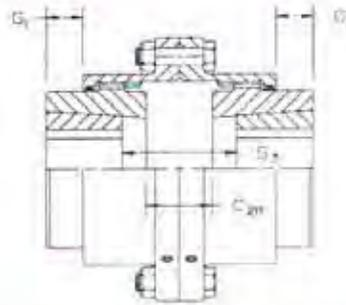

**Full Flex - Both Hubs Reversed
Outboard - Outboard**

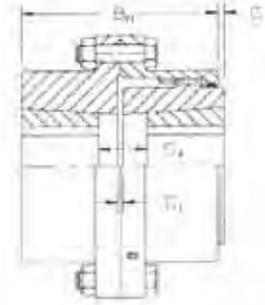

**Flex Rigid - Standard Mount
Outboard - Outboard**

Series F	Size	1	1½	2	2½	3	3½	4
Rating (HP/100 RPM)	(2)	4	8	15	29	50	80	120
Torque Capacity (IN·LBS x 10³)		2.5	5	9.5	18.3	31.5	50.4	75.6
Maximum Speed (RPM)	(1)	6900	5660	4850	4100	3650	3180	2710
DTL Bushing Number		1215	1615	2012	2525	3030	3535	4040
Parallel Offset Capacity		.056	.069	.089	.108	.128	.153	.176
A		4.56	6.00	7.00	8.38	9.44	11.00	12.50
B		3.31	3.88	4.84	6.00	6.94	8.38	9.34
C		.13	.13	.13	.19	.19	.25	.25
C1R		.38	.72	.98	1.09	1.38	1.72	1.97
C2R		.75	1.31	1.84	2.00	2.56	3.19	3.69
E		1.69	1.94	2.44	3.03	3.59	4.19	4.75
F		3.11	3.91	4.88	5.91	6.88	7.91	9.25
G		.09	.06	.06	.13	.22	.13	.20
G1		.41	.66	.89	1.03	1.31	1.59	1.92
O		2.36	3.05	3.97	4.88	5.63	6.50	7.75
L		1.50	1.50	1.25	2.50	3.00	3.50	4.00
S1		.75	1.69	3.36	2.16	2.56	3.09	3.47
S2		.50	1.00	2.50	1.25	1.38	1.63	1.75
S3		1.13	2.19	4.22	3.06	3.56	4.56	5.19
S4		1.50	1.50	1.25	2.50	3.00	3.50	4.00

Notes:

- (1) Speed limits are recommendations based on experience and are intended as a guide only. Consult SCI for speeds higher than those listed.
- (2) Load ratings / torque capacities are based on bushing size. Selection service factors are required. See Data Sheet DS110.
- (3) Maximum angular misalignment 1 1/2° per gear mesh. For optimum performance, combined angular and offset misalignment should not exceed 3/4° per gear mesh. Application requirements in excess of 3/4° misalignment per flex half coupling should be referred to SCI.

Consult engineering for larger sizes.

Flex hubs or rigid hubs can be provided with either inboard or outboard mount bores.

Unless otherwise specified standard mount with inboard - inboard hubs supplied.



MAGZA
DIST. AUTORIZADO

MEX (55) 53 63 23 31 MTY (81) 83 54 10 18
QRO (442) 1 95 72 60 ventas@industrialmagza.com

Series "F" Full Flex Limited End Float Couplings.

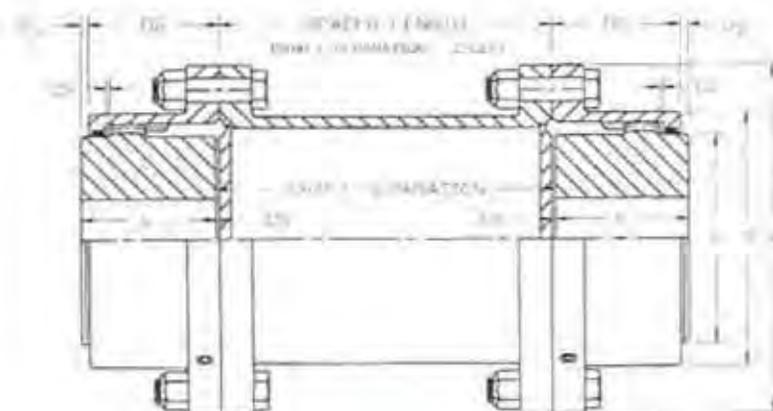

**Full Flex
Limited End Float (L.E.F.)
Spacer Coupling**

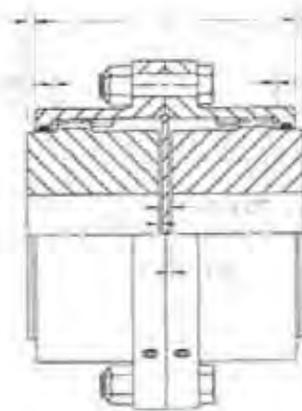

**Full Flex
Limited End Float (L.E.F.)
Coupling**

Series F	Size	1	1½	2	2½	3	3½	4	4½	5	5½	6	7
Rating (HP/100 RPM)	(2)	15.6	31	51	90	152	240	380	500	710	925	1200	1850
Torque Capacity (IN-LBS x 10 ³)		9.77	19.5	32.1	56.7	96	151	240	315	447	583	756	1166
Maximum Speed (RPM)	(1)	10800	8800	8300	7670	7150	6330	5670	5160	4650	4350	3820	3150
Flex Hub	Maximum Bore	1.63	2.19	2.75	3.50	4.00	4.50	5.50	6.00	6.88	7.75	8.75	10.38
	Standard Keyway	3/8 x 3/16	1/2 x 1/4	5/8 x 5/16	7/8 x 7/16	1 x 1/2	1 x 1/2	1-1/4 x 5/8	1-1/2 x 3/4	1-3/4 x 3/4	2 x 3/4	2 x 3/4	2-1/2 x 7/8
Hub	Maximum Bore	1.75	2.31	2.88	3.75	4.38	5.00	5.88	6.50	7.13	8.00	9.00	10.63
	Reduced Depth Keyway	3/8 x 1/8	5/8 x 3/16	3/4 x 3/16	7/8 x 5/16	1 x 5/16	1-1/4 x 3/8	1-1/2 x 1/2	1-1/2 x 1/2	1-3/4 x 5/8	2 x 5/8	2 x 5/8	2-1/2 x 3/4
A		4.56	6.00	7.00	8.38	9.44	11.00	12.50	13.63	15.31	16.75	18.00	20.75
B		3.31	3.88	4.84	6.00	6.94	8.38	9.34	10.50	11.81	13.13	13.31	15.25
DS		1.66	1.94	2.42	3.00	3.47	4.19	4.67	5.25	5.91	6.57	6.66	7.63
C-LEF		.19	.19	.19	.28	.28	.41	.41	.53	.53	.59	.59	.78
CS		.031	.031	.031	.047	.047	.047	.047	.047	.047	.047	.047	.047
Total End Float		.13	.13	.13	.19	.19	.19	.19	.19	.19	.19	.19	.19
E		1.69	1.94	2.44	3.03	3.59	4.19	4.75	5.31	6.03	6.63	7.41	8.69
F		3.11	3.91	4.88	5.91	6.88	7.91	9.25	10.31	11.56	12.59	13.88	16.09
G2		.13	.09	.11	.17	.27	.20	.28	.33	.39	.33	1.02	1.39
O		2.36	3.05	3.97	4.88	5.63	6.50	7.75	8.50	9.50	10.50	11.63	13.50
Rough Stock Bore		-	-	-	-	-	-	2.09	2.25	2.25	2.75	3.00	4.00
Grease (5)	Weight (LB-OZ.)	0-1.1	0-2.3	0-5	0-6.5	0-9.5	1-7	1-11	2-11	3-11	5-5	7-12	10-5
	Volume (Pints)	.06	.06	.25	.60	.86	1.5	1.8	2.9	4.0	5.4	8.2	11.2

Notes:

- (1) Maximum speed without dynamic balancing 60% of values shown. Speed limits are recommendations based on experience and are intended as a guide only. Consult SCI for speeds higher than those listed. Maximum speed values for spacer couplings and for speeds higher than those listed consult SCI.
- (2) Load ratings / torque capacities are based on full 1° misalignment per gear mesh. Selection service factors are required. See Data Sheet DS110.
- (3) Maximum angular misalignment 1 1/2° per gear mesh. For optimum performance, combined angular and offset misalignment should not exceed 3/4° per gear mesh. Application requirements in excess of 3/4° misalignment per flex half coupling should be referred to SCI.
- (4) Sizes 5½, 6 and 7 not available in shrouded bolt.
- (5) Lubrication values are for full flex couplings.
For spacer couplings, half of lubricant per half coupling.



POWERTORK®

DATA SHEET DS115 REV. 04

Series "F" Full Flex Spacer Couplings.

Full Flex Spacer Coupling

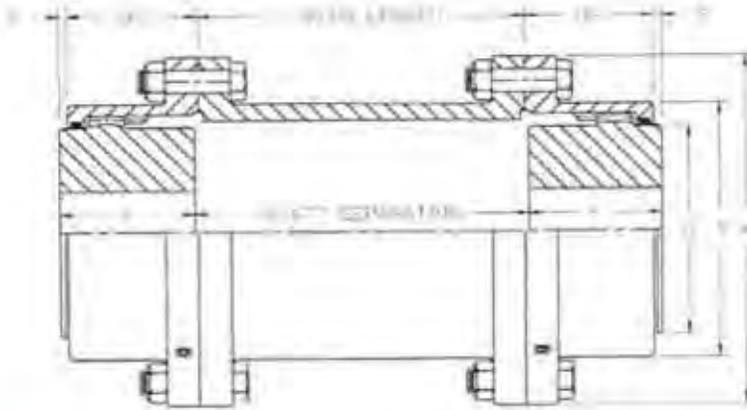

Stock Spacers

Size	1	1½	2	2½	3	3½		
End Float	.25	.25	.25	.38	.38	.50		
S H A F T S E P E R A T I O N	3.50	S P A C E R L E N G T H	3.38	3.38	3.38	-	-	-
			4.25	4.25	4.25	-	-	-
			4.88	4.88	4.88	4.81	4.81	4.75
			6.88	6.88	6.88	6.81	6.81	6.75
			9.88	9.88	9.88	9.81	9.81	9.75

Series F	Size	1	1½	2	2½	3	3½	4	4½	5	5½	6	7
Rating (HP/100 RPM)	(2)	15.5	31	51	90	152	240	380	500	710	925	1200	1850
Torque Capacity (IN·LBS × 10³)		9.77	19.5	32.1	56.7	96	151	240	315	447	583	756	1166
Maximum Speed (RPM)	(1)	10800	8800	8300	7670	7150	6330	5670	5160	4650	4350	3820	3150
Flex	Maximum Bore	1.63	2.19	2.75	3.50	4.00	4.50	5.50	6.00	6.88	7.75	8.75	10.38
	Standard Keyway	3/8 × 3/16	1/2 × 1/4	5/8 × 5/16	7/8 × 7/16	1 × 1/2	1 × 1/2	1-1/4 × 5/8	1-1/2 × 3/4	1-3/4 × 3/4	2 × 3/4	2 × 3/4	2-1/2 × 7/8
Hub	Maximum Bore	1.75	2.31	2.88	3.75	4.38	5.00	5.88	6.50	7.13	8.00	9.00	10.63
	Reduced Depth Keyway	3/8 × 1/8	5/8 × 3/16	3/4 × 3/16	7/8 × 5/16	1 × 5/16	1-1/4 × 3/8	1-1/2 × 1/2	1-1/2 × 1/2	1-3/4 × 5/8	2 × 5/8	2 × 5/8	2-1/2 × 3/4
A		4.56	6.00	7.00	8.38	9.44	11.00	12.50	13.63	15.31	16.75	18.00	20.75
DS		1.66	1.94	2.42	3.00	3.47	4.19	4.67	5.25	5.91	6.57	6.66	7.63
C		.13	.13	.13	.19	.19	.25	.25	.31	.31	.31	.31	.38
E		1.69	1.94	2.44	3.03	3.59	4.19	4.75	5.31	6.03	6.63	7.41	8.69
F		3.11	3.91	4.88	5.91	6.88	7.91	9.25	10.31	11.56	12.59	13.88	16.09
G		.09	.06	.06	.13	.22	.13	.20	.22	.28	.22	.91	1.25
D		2.36	3.05	3.97	4.88	5.63	6.50	7.75	8.50	9.50	10.50	11.63	13.50
Rough Stock Bore		-	-	-	-	-	-	2.09	2.25	2.25	2.75	3.00	4.00
Grease	Weight (LB-OZ.)	0-1.1	0-2.3	0-5	0-6.5	0-9.5	1-7	1-11	2-11	3-11	5-5	7-12	10-5
	(5) Volume (Pints)	.06	.06	.25	.60	.86	1.5	1.8	2.9	4.0	5.4	8.2	11.2

Notes:

- (1) Maximum speed without dynamic balancing 60% of values shown. Speed limits are recommendations based on experience and are intended as a guide only. Consult SCI for speeds higher than those listed. Maximum speed values for spacer couplings and for speeds higher than those listed consult SCI.
- (2) Load ratings / torque capacities are based on full 1° misalignment per gear mesh. Selection service factors are required. See Data Sheet DS110.
- (3) Maximum angular misalignment 1 1/2° per gear mesh. For optimum performance, combined angular and offset misalignment should not exceed 3/4° per gear mesh. Application requirements in excess of 3/4° misalignment per flex half coupling should be referred to SCI.
- (4) Sizes 5½, 6 and 7 not available in shrouded bolt.
- (5) Lubrication values are for full flex couplings.
For spacer couplings, half of lubricant per half coupling.



INDUSTRIAL MAGZA
DIST. AUTORIZADO

MEX (55) 53 63 23 31 MTY (81) 83 54 10 18
QRO (442) 1 95 72 60 ventas@industrialmagza.com

Series "F" Mill Motor Flange Type Gear Coupling.

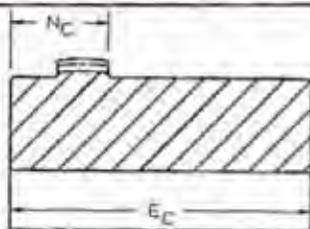

**Rough Bored
Composite Hub**

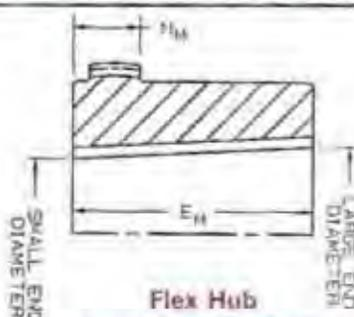

**Flex Hub
For AISE Mill Motors**



**Rigid Hub
For AISE Mill Motors**

CPLG Size	AISE Mill motor Frame Sizes	Composite Hub		Flex Hub And Rigid Hub Bored For AISE Mill Motor Frame								
		E _c	N _c	E _m	N _m	C _m	D _m	T	S	Large End Diameter	Small End Diameter	Keyway
1½	802	3.50	.88	3.00	.88	.75	3.72	.72	3.00	1.749	1.4305	1/2 x 1/4
2	602	4.00	.97		.97	1.06	4.03	1.03	4.00			
2½	AC1,2,3	5.16	1.44		1.44	1.13			5.00			
1½	803	3.50	.88	3.50	.88	.75	4.22	.72	3.00	1.999	1.6344	1/2 x 1/4
2	804	4.00	.97		.97	1.06	4.63	1.03	4.00			
2½	603	5.16	1.44		1.38	1.19	4.59	1.09	5.00			
3	604	5.63	1.81		1.81	1.19			6.00			
2	806	4.00	.97	4.00	.97	1.06	5.03	1.03	4.00	2.499	2.0823	1/2 x 1/4
2½	608	5.16	1.44		1.25	1.31			5.00			
3	AC8	5.63	1.81		1.69	1.31	5.22	1.22	6.00			
3½	AC12	6.13	2.25		2.25	1.38			7.00			
2½	808	5.16	1.44	4.50	1.28	1.28	5.69	1.19	5.00	2.9985	2.5298	3/4 x 1/4
3	608	5.63	1.81		1.56	1.44	5.84	1.34	6.00			
3½		6.13	2.25		2.13	1.50			7.00			
2½	810	5.16	1.44	4.50	1.28	1.28	5.69	1.19	5.00	3.2485	2.7798	3/4 x 1/4
3	610	5.63	1.81		1.44	1.56	5.97	1.47	6.00			
3½	AC18	6.13	2.25		2.00	1.63			7.00			
4		6.00	2.55		2.48	1.63	6.06	1.56	8.00			
2½	812	5.16	1.44	5.00	1.28	1.28	6.19	1.19	5.00	3.623	3.1022	3/4 x 1/4
3	612	5.63	1.81		1.31	1.69	6.59	1.59	6.00			
3½	AC25	6.13	2.25		1.88	1.75			7.00			
4	AC30	6.00	2.55		2.36	1.75	6.69	1.69	8.00			
4½		7.19	3.22		2.68	1.81			9.00			
3	814	5.63	1.81	5.00	1.19	1.69	6.72	1.72	6.00	4.248	3.7272	1 x 3/8
3½	614	6.13	2.25		1.75	1.88			7.00			
4	AC40	6.00	2.55		2.23	1.88			8.00			
4½	AC50	7.19	3.22		2.75	1.94	6.81	1.81	9.00			
5		8.31	3.66		3.24	1.94			10.00			
3½	816	6.13	2.25	5.50	1.63	2.00	7.34	1.84	7.00	4.6225	4.0496	1-1/4 x 3/8
4	616	6.00	2.55		2.11	2.00			8.00			
4½		7.19	3.22		2.63	2.06	7.44	1.94	9.00			
5		8.31	3.66		3.22	2.06			10.00			
5½		10.31	4.25		3.81	2.06	7.50	2.00	11.00			
6		10.31	4.28		3.84	2.06			11.00			
4	818	6.00	2.55	6.00	2.55	1.56			8.00	4.9975	4.3725	1-1/4 x 1/2
4½	618	7.19	3.22		3.06	1.63	7.50	1.50	9.00			
5		8.31	3.66		3.66	1.63			10.00			
5½		10.31	4.25		4.25	1.63	7.56	1.56	11.00			
6		10.31	4.28		4.28	1.63			11.00			
4½	620	7.19	3.22	6.75	2.63	2.06	8.69	1.94	9.00	5.872	5.1689	1-1/2 x 3/4
5		8.31	3.66		3.22	2.06			10.00			
5½		10.31	4.25		3.81	2.06	8.75	2.00	11.00			
6		10.31	4.28		3.84	2.06			11.00			
5	622	8.31	3.66	7.25	2.59	2.69	9.81	2.56	10.00	6.247	5.4918	1-1/2 x 3/4
5½		10.31	4.25		3.19	2.69	9.88	2.63	11.00			
6		10.31	4.28		3.22	2.69			11.00			
5½	624	10.31	4.25	9.25	3.19	2.69	11.88	2.63	11.00	6.9965	6.033	1-1/2 x 3/4
6		10.31	4.28		3.22	2.69			11.00			

Notes:

- (1) All keyways parallel to the taper bore.
- (2) All tapers are 1-1/4" per foot on diameter.
- (3) All ratings are the same as the standard series F couplings found on Data Sheet DS100.
- (4) For dimensions not tabulated above, see reverse side of Data Sheet.

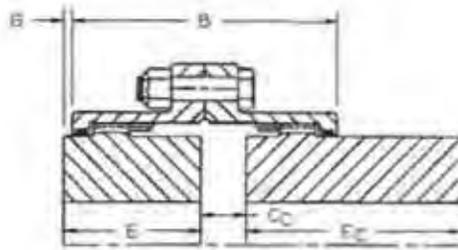
POWERTORK[®]**Series "F" Mill Motor Flange Type Gear Coupling.**

**Full Flex Mill Motor Coupling
With Rough Bored Composite Hub**

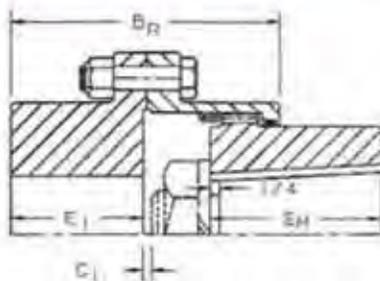

**Flex Rigid Mill Motor Coupling
For AISE Mill Motors**

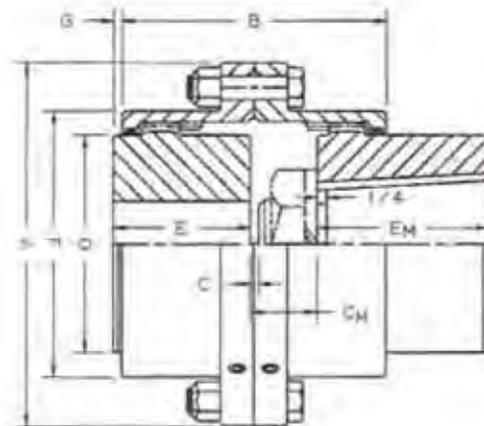

**Full Flex Mill Motor Coupling
For AISE Mill Motors**

Series F	Size	1½	2	2½	3	3½	4	4½	5	5½	6
A		6.00	7.00	8.38	9.44	11.00	12.50	13.63	15.31	16.75	18.00
B		3.88	4.84	6.00	6.94	8.38	9.34	10.50	11.81	13.13	13.31
BR		3.85	4.80	6.00	6.97	8.25	9.30	10.44	11.78	12.94	14.31
C		.13	.13	.19	.19	.25	.25	.31	.31	.31	.31
CC		.75	1.06	1.13	1.19	1.38	1.56	1.63	1.63	1.63	1.63
C1		.16	.16	.19	.19	.22	.31	.34	.34	.41	.41
E		1.94	2.44	3.03	3.59	4.19	4.75	5.31	6.03	6.63	7.41
EC		3.50	4.00	5.16	5.63	6.13	6.00	7.19	8.31	10.31	10.31
E1		1.84	2.28	2.91	3.41	3.97	4.44	5.00	5.69	6.05	7.41
F		3.91	4.88	5.91	6.88	7.91	9.25	10.31	11.56	12.59	13.88
G		.06	.06	.13	.22	.13	.20	.22	.28	.22	.91
NC		.88	.97	1.44	1.81	2.25	2.55	3.22	3.66	4.25	4.28
O		3.05	3.97	4.88	5.63	6.50	7.75	8.50	9.50	10.50	11.63
Rough Stock Bore		-	-	-	-	-	2.25	2.25	3.00	3.00	3.00

Notes:

- (1) All keyways parallel to the taper bore.
- (2) All tapers are 1-1/4" per foot on diameter.
- (3) Sizes 5½ and 6 not available in shrouded bolt.
- (4) All ratings are the same as the standard series F couplings found on Data Sheet DS100.
- (5) For dimensions CM and DM, see reverse side of data sheet.



MAGZA
DIST. AUTORIZADO

MEX (55) 53 63 23 31 MTY (81) 83 54 10 18
QRO (442) 1 95 72 60 ventas@industrialmagza.co

POWERTORK®

DATA SHEET DS118 REV. 04

Series "F" Full Flex Vertical Gear Coupling.

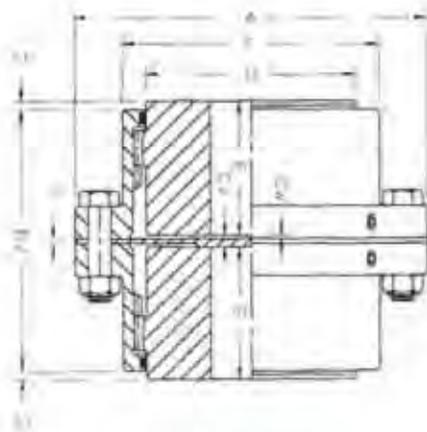

Non Supported
Upper Shaft

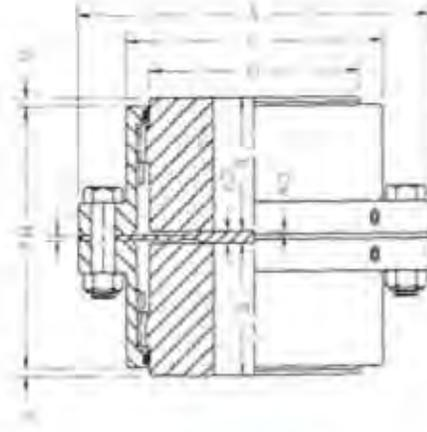

Supported
Upper Shaft

Series F		Size	1	1½	2	2½	3	3½	4	4½	5	5½	6	7
Rating (HP/100 RPM)	(2)		15.5	31	51	90	152	240	380	500	710	925	1200	1850
Torque Capacity (IN-LBS x 10³)			9.77	19.5	32.1	56.7	96	151	240	315	447	583	756	1166
Maximum Speed (RPM)	(1)		10800	8800	8300	7670	7150	6330	5670	5160	4650	4350	3820	3150
Flex Hub	Maximum Bore		1.63	2.19	2.75	3.50	4.00	4.50	5.50	6.00	6.88	7.75	8.75	10.38
	Standard Keyway		3/8 x 3/16	1/2 x 1/4	5/8 x 5/16	7/8 x 7/16	1 x 1/2	1 x 1/2	1-1/4 x 5/8	1-1/2 x 3/4	1-3/4 x 3/4	2 x 3/4	2 x 3/4	2-1/2 x 7/8
	Maximum Bore		1.75	2.31	2.88	3.75	4.38	5.00	5.88	6.50	7.13	8.00	9.00	10.63
	Reduced Depth Keyway		3/8 x 1/8	5/8 x 3/16	3/4 x 3/16	7/8 x 5/16	1 x 5/16	1-1/4 x 3/8	1-1/2 x 1/2	1-1/2 x 1/2	1-3/4 x 5/8	2 x 5/8	2 x 5/8	2-1/2 x 3/4
Parallel Offset Capacity			.056	.069	.089	.108	.128	.153	.176	.201	.229	.256	.255	.301
A			4.56	6.00	7.00	8.38	9.44	11.00	12.50	13.63	15.31	16.75	18.00	20.75
BV			3.44	4.00	4.97	6.13	7.06	8.56	9.53	10.89	12.00	13.38	13.56	15.50
CV			.25	.25	.25	.31	.31	.44	.44	.50	.50	.56	.56	.69
CW			.06	.06	.06	.09	.09	.13	.13	.16	.16	.16	.16	.19
E			1.69	1.94	2.44	3.03	3.59	4.19	4.75	5.31	6.03	6.63	7.41	8.69
F			3.11	3.91	4.88	5.91	6.88	7.91	9.25	10.31	11.56	12.59	13.88	16.09
G			.09	.06	.06	.13	.22	.13	.20	.22	.28	.22	.91	1.25
O			2.36	3.05	3.97	4.88	5.63	6.50	7.75	8.50	9.50	10.50	11.63	13.50
T			.13	.13	.13	.13	.13	.19	.19	.19	.19	.25	.25	.31
Rough Stock Bore			-	-	-	-	-	-	2.09	2.25	2.25	2.75	3.00	4.00
Weight Solid Hubs (LBS)		(3)	9.5	19	31.5	61	85.5	136.5	207	276.5	396.5	481.5	664	1014
(4)	Grease Weight (LB-OZ.)		0-1.1	0-2.3	0-5	0-6.5	0-9.5	1-7	1-11	2-11	3-11	5-5	7-12	10-5
	Volume (Pints)		.06	.06	.25	.60	.86	1.5	1.8	2.9	4.0	5.4	8.2	11.2

Notes:

- (1) Maximum speed without dynamic balancing 60% of values shown. Speed limits are recommendations based on experience and are intended as a guide only. Consult SCI for speeds higher than those listed.
- (2) Load ratings / torque capacities are based on full 1° misalignment per gear mesh. Selection service factors are required. See Data Sheet DS110.
- (3) Weights are for full flex couplings. Weights are approximate.
- (4) Lubrication values are for full flex couplings.
- (5) Maximum angular misalignment 1 1/2° per gear mesh. For optimum performance, combined angular and offset misalignment should not exceed 3/4° per gear mesh. Application requirements in excess of 3/4° misalignment per flex half coupling should be referred to SCI.
- (6) Sizes 5½, 6 and 7 not available in shrouded bolt.



INDUSTRIAL MAGZA
DISTR. AUTORIZADO

MEX (55) 53 63 23 31
QRO (442) 1 95 72 60

MTY (81) 83 54 10 18
ventas@industrialmagza.com

POWERTORK®

DATA SHEET DST02 REV. 03

Series "F" Rigid Rigid Flange Type Gear Coupling.

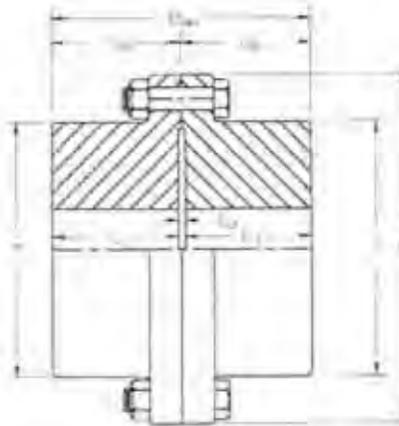

Series F	Size	1	1½	2	2½	3	3½	4	4½	5	5½	6	7
Rating (HP/100 RPM)		15.5	31	51	90	152	240	380	500	710	925	1200	1850
Torque Capacity (IN · LBS x 10 ³)		9.77	19.5	32.1	56.7	96	151	240	315	447	583	756	1166
Maximum Speed (RPM)	(1)	10800	8800	8300	7670	7150	6330	5670	5160	4650	4350	3820	3150
Rigid	Maximum Bore	2.25	2.75	3.25	4.38	5.00	5.63	6.75	7.75	8.88	9.50	10.75	12.63
	Standard Keyway	1/2 x 1/4	5/8 x 3/16	3/4 x 3/8	1 x 1/2	1-1/4 x 5/8	1-1/2 x 3/4	1-3/4 x 3/4	2 x 3/4	2 x 3/4	2-1/2 x 7/8	2-1/2 x 7/8	3 x 1
Hub	Maximum Bore	2.44	3.00	3.50	4.50	5.50	6.13	7.00	8.25	9.13	10.00	11.00	13.13
	Reduced Depth Keyway	5/8 x 3/16	3/4 x 3/16	7/8 x 1/4	1 x 3/8	1-1/4 x 3/8	1-1/2 x 1/2	1-3/4 x 5/8	2 x 1/2	2-1/2 x 5/8	2-1/2 x 5/8	2-1/2 x 5/8	3 x 3/4
A		4.56	6.00	7.00	8.38	9.44	11.00	12.50	13.63	15.31	16.75	18.00	20.75
BRR		3.31	3.84	4.75	6.00	7.00	8.12	9.22	10.34	11.72	12.61	15.31	18.00
C2		.19	.19	.19	.19	.19	.19	.38	.38	.38	.50	.50	.63
DR		1.65	1.92	2.38	3.00	3.50	4.06	4.61	5.17	5.86	6.30	7.66	9.00
E1		1.56	1.84	2.28	2.91	3.41	3.97	4.42	4.98	5.67	6.05	7.41	8.69
F		3.11	3.91	4.88	5.91	6.88	7.91	9.25	10.31	11.56	12.59	13.88	16.09
Rough Stock Bore		-	-	-	-	-	-	2.09	2.25	2.25	2.75	3.00	4.00
Weight Solid Hubs (LBS)		(2)	9	18	30	59	83	131	200	268	386	465	988

Notes:

- (1) Maximum speed without dynamic balancing 60% of values shown. Speed limits are recommendations based on experience and are intended as a guide only. Consult SCI for speeds higher than those listed.
- (2) Weights are for rigid rigid couplings. Weights are approximate.
- (3) Sizes 5½, 6 and 7 not available in shrouded bolt.

POWERTORK®

DATA SHEET DS109 REV. 02

Series "F" Flex Rigid Heavy Duty Flange Type Gear Coupling. (Sizes 16 to 30)

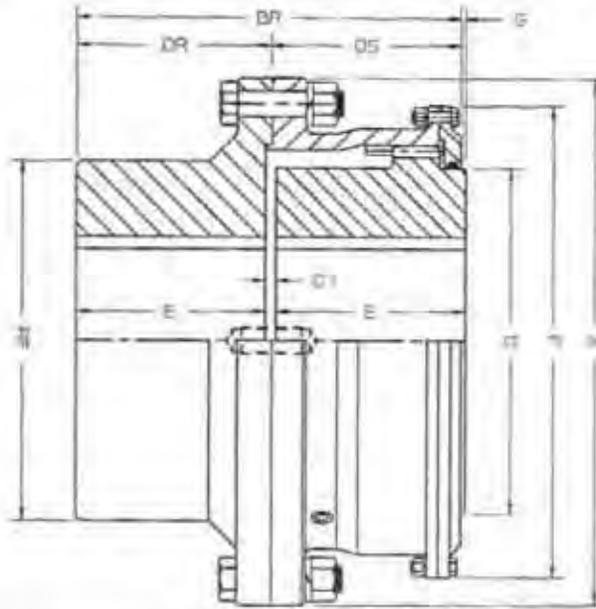

Series F	Size	16	18	20	22	24	26	28	30
Rating (HP/100 RPM)		16150	21150	28850	38200	42500	53000	66000	80500
Torque Capacity (IN-LBS x 10 ³)		10179	13330	18183	24076	26786	33403	41597	50735
Maximum Speed (RPM)	(1)	750	500	400	300	200	200	200	200
Flex Hub	Maximum Bore	22.50	25.75	27.75	30.50	33.75	37.25	40.50	44.00
	Standard Keyway	6 x 2	6 x 2	7 x 2-1/2	7 x 2-1/2	8 x 3	8 x 3	8 x 3	8 x 3
Rigid Hub	Maximum Bore	24.00	27.25	29.25	32.00	35.75	39.25	42.50	46.00
	Reduced Depth Keyway	6 x 1-1/4	6 x 1-1/4	7 x 1-3/4	7 x 1-3/4	8 x 2	8 x 2	8 x 2	8 x 2
Flex Hub	Maximum Bore	22.00	25.00	26.00	27.00	28.00	29.00	30.00	36.00
	Standard Keyway	5 x 1-3/4	6 x 2	6 x 2	7 x 2-1/2	7 x 2-1/2	7 x 2-1/2	7 x 2-1/2	8 x 3
Rigid Hub	Maximum Bore	23.50	26.50	27.50	28.50	29.50	30.50	31.50	38.00
	Reduced Depth Keyway	6 x 1	7 x 1-1/4	7 x 1-1/4	7 x 1-3/4	7 x 1-3/4	7 x 1-3/4	7 x 1-3/4	8 x 2
A		43.00	47.25	53.50	59.00	64.25	68.50	73.75	78.00
BR		35.38	36.56	42.81	46.63	50.13	53.63	54.88	55.88
C1		1.00	1.00	1.00	1.13	1.13	1.13	1.13	1.13
DR		17.88	18.50	21.63	23.63	25.38	27.13	27.75	28.25
DS		17.50	18.06	21.19	23.00	24.75	26.50	27.13	27.63
E		17.38	18.00	21.13	23.00	24.75	26.50	27.13	27.63
F		38.88	43.13	48.38	52.88	57.38	61.63	66.19	70.69
G		.38	.44	.44	.50	.50	.50	.50	.50
O		29.50	33.50	37.00	40.50	45.00	49.00	53.00	57.00
RF		30.00	34.00	36.00	38.00	40.00	42.00	44.00	50.00
Rough Stock Bore	(5)	13.0	15.0	17.0	19.0	21.0	23.0	25.0	27.0
Weight Solid Hubs (LBS)	(2)	9400	12400	16500	21000	26000	31500	36500	43000
Grease	Weight (LB-OZ.)	37-8	45	62-8	75	87-8	95	105	112-8
	Volume (Pints)	40	48	67	80.5	93.5	101.5	112.5	120.5

Notes:

- (1) Speed limits are recommendations based on experience and are intended as a guide only. Consult SCI for speeds higher than those listed.
- (2) Weights are for flex rigid couplings. Weights are approximate.
- (3) Lubrication values are for flex rigid couplings.
- (4) Maximum angular misalignment 1/2° per gear mesh.
Applications in excess of 1/2° misalignment per flex half coupling should be referred to SCI.
- (5) For smaller minimum bore sizes consult SCI.
- (6) Refer to Data Sheet DS110 for service factors.
- (7) Refer to reverse side of data sheet for sizes 8 to 15.



INDUSTRIAL MAGZA
DIST. AUTORIZADO

MEX (55) 53 63 23 31 MTY (81) 83 54 10 18
QRO (442) 1 95 72 60 ventas@industrialmagza.com

POWERTORK®

DATA SHEET DS109 REV. 02

Series "F" Flex Rigid Heavy Duty Flange Type Gear Coupling. (Sizes 8 to 15)

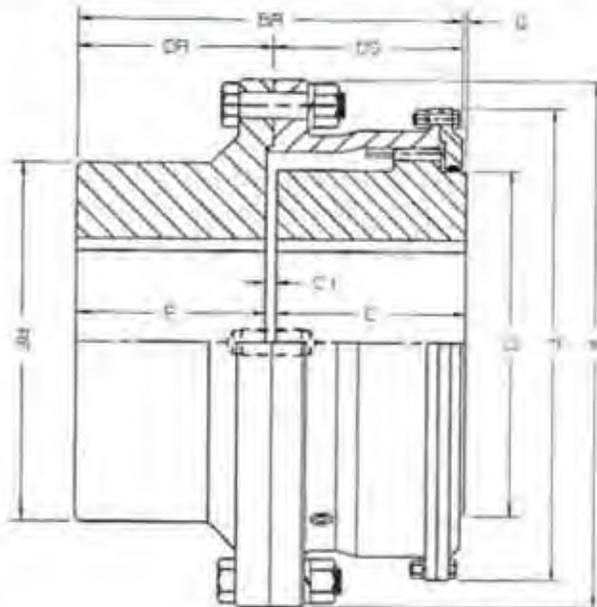

Series F	Size	8	9	10	11	12	13	14	15
Rating (HP/100 RPM)		2250	3200	4375	5800	7200	9050	11100	13500
Torque Capacity (IN-LBS x 10 ³)		1418	2017	2757	3656	4538	5704	6998	8508
Maximum Speed (RPM)	(1)	1750	1625	1500	1375	1250	1125	1000	875
Flex Hub	Maximum Bore	10.75	12.25	13.50	15.00	16.50	18.00	19.25	21.25
	Standard Keyway	2-1/2 x 7/8	3 x 1	3-1/2 x 1-1/4	3-1/2 x 1-1/4	4 x 1/2	4 x 1/2	5 x 1-3/4	5 x 1-3/4
	Reduced Depth Keyway	2-1/2 x 5/8	3 x 3/4	3-1/2 x 7/8	4 x 1	4 x 1	5 x 1-1/4	5 x 1-1/4	5 x 1-1/4
Rigid Hub	Maximum Bore	11.00	13.00	13.50	15.00	16.50	18.00	19.25	20.50
	Standard Keyway	2-1/2 x 7/8	3 x 1	3-1/2 x 1-1/4	3-1/2 x 1-1/4	4 x 1-1/2	4 x 1-1/2	5 x 1-3/4	5 x 1-3/4
	Reduced Depth Keyway	2 x 3/8	3-1/2 x 7/8	3-1/2 x 7/8	4 x 7/8	4 x 1	5 x 1	5 x 1	5 x 1
A		23.25	26.00	28.00	30.50	33.00	35.75	38.00	40.50
BR		19.88	22.06	24.38	26.63	28.13	29.75	31.50	33.44
C1		.38	.50	.50	.50	.50	.75	.75	.75
DR		10.13	11.19	12.38	13.50	14.25	15.00	15.88	16.88
DS		9.75	10.88	12.00	13.13	13.88	14.75	15.63	16.56
E		9.81	10.88	12.00	13.13	13.88	14.63	15.50	16.50
F		20.50	23.00	25.13	27.31	29.81	32.00	34.13	36.75
G		.25	.25	.25	.25	.25	.25	.25	.31
O		14.00	16.00	18.00	20.00	21.75	23.50	25.50	27.50
RF		15.25	17.50	19.00	20.75	23.00	24.75	26.50	28.00
Rough Stock Bore	(5)	5.0	6.0	7.0	8.0	9.0	10.0	11.0	12.0
Weight Solid Hubs (LBS)	(2)	1580	2060	2850	3480	4400	5600	6700	8000
Grease	Weight (LB-OZ.)	7	12	14	19	21.8	23.8	27.8	31
	Volume (Pints)	7.5	13	15	20.5	23	25	29.5	33

Notes:

- (1) Speed limits are recommendations based on experience and are intended as a guide only. Consult SCI for speeds higher than those listed.
- (2) Weights are for flex rigid couplings. Weights are approximate.
- (3) Lubrication values are for flex rigid couplings.
- (4) Maximum angular misalignment 1/2° per gear mesh.
Applications in excess of 1/2° misalignment per flex half coupling should be referred to SCI.
- (5) For smaller minimum bore sizes consult SCI.
- (6) Refer to Data Sheet DS110 for service factors.
- (7) Refer to reverse side of data sheet for sizes 16 to 30.



MAGZA
DIST. AUTORIZADO

MEX (55) 53 63 23 31 MTY (81) 83 54 10 18
ORO (442) 1 95 72 60 ventas@industrialmagza.com

POWERTORK®

DATA SHEET DS101 REV. 04

Series "F" Flex Rigid Flange Type Gear Coupling. Series "F" Floating Shaft Flange Type Gear Coupling.

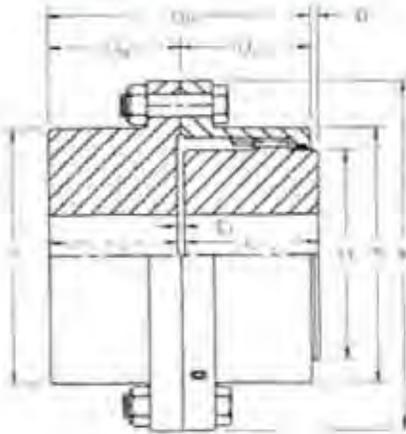

Flex Rigid Flange Type

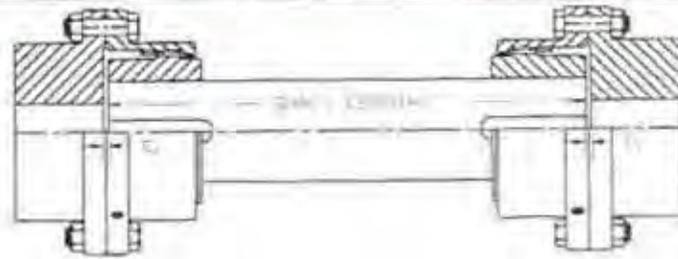

Floating Shaft Flange Type - Rigid Outboard

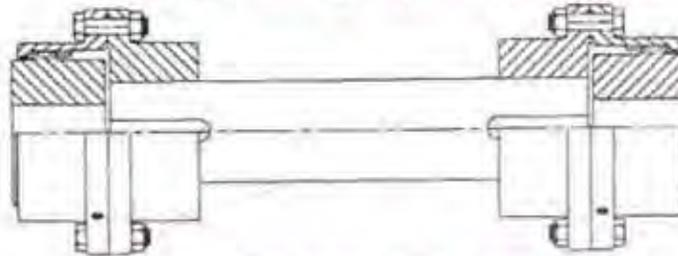

Floating Shaft Flange Type - Rigid Inboard

Series F	Size	1	1½	2	2½	3	3½	4	4½	5	5½	6	7
Rating (HP/100 RPM)	(2)	15.5	31	51	90	152	240	380	500	710	925	1200	1850
Torque Capacity (IN-LBS × 10³)		9.77	19.5	32.1	56.7	96	151	240	315	447	583	756	1166
Maximum Speed (RPM)	(1)	10800	8800	8300	7670	7150	6330	5670	5160	4650	4350	3820	3150
Flex Hub	Maximum Bore	1.63	2.19	2.75	3.50	4.00	4.50	5.50	6.00	6.88	7.75	8.75	10.38
	Standard Keyway	3/8 × 3/16	1/2 × 1/4	5/8 × 3/16	7/8 × 7/16	1 × 1/2	1 × 1/2	1-1/4 × 5/8	1-1/2 × 3/4	1-3/4 × 3/4	2 × 3/4	2 × 3/4	2-1/2 × 7/8
	Maximum Bore	1.75	2.31	2.88	3.75	4.38	5.00	5.88	6.50	7.13	8.00	9.00	10.63
Rigid Hub	Reduced Depth Keyway	3/8 × 1/8	5/8 × 3/16	3/4 × 3/16	7/8 × 3/16	1 × 5/16	1-1/4 × 3/8	1-1/2 × 1/2	1-1/2 × 1/2	1-3/4 × 5/8	2 × 5/8	2 × 5/8	2-1/2 × 3/4
	Maximum Bore	2.25	2.75	3.25	4.38	5.00	5.63	6.75	7.75	8.88	9.50	10.75	12.63
	Standard Keyway	1/2 × 1/4	5/8 × 5/16	3/4 × 3/8	1 × 1/2	1-1/4 × 5/8	1-1/2 × 3/4	1-3/4 × 3/4	2 × 3/4	2 × 3/4	2-1/2 × 7/8	2-1/2 × 7/8	3 × 1
A	Maximum Bore	2.44	3.00	3.50	4.50	5.50	6.13	7.00	8.25	9.13	10.00	11.00	13.13
	Standard Keyway	5/8 × 3/16	3/4 × 3/16	7/8 × 1/4	1 × 3/8	1-1/4 × 3/8	1-1/2 × 1/2	1-3/4 × 5/8	2 × 1/2	2-1/2 × 5/8	2-1/2 × 5/8	2-1/2 × 5/8	3 × 3/4
	Reduced Depth Keyway	5/8 × 3/16	3/4 × 3/16	7/8 × 1/4	1 × 3/8	1-1/4 × 3/8	1-1/2 × 1/2	1-3/4 × 5/8	2 × 1/2	2-1/2 × 5/8	2-1/2 × 5/8	2-1/2 × 5/8	3 × 3/4
A		4.56	6.00	7.00	8.38	9.44	11.00	12.50	13.63	15.31	16.75	18.00	20.75
BR		3.31	3.85	4.80	6.00	6.97	8.25	9.28	10.44	11.78	12.94	14.31	16.63
C1		.16	.16	.16	.19	.19	.22	.31	.34	.34	.41	.41	.50
DR		1.65	1.92	2.38	3.00	3.50	4.06	4.61	5.17	5.86	6.30	7.66	9.00
DS		1.66	1.94	2.42	3.00	3.47	4.19	4.67	5.25	5.91	6.57	6.66	7.63
E		1.69	1.94	2.44	3.03	3.59	4.19	4.75	5.31	6.03	6.63	7.41	8.69
E1		1.56	1.84	2.28	2.91	3.41	3.97	4.42	5.00	5.69	6.05	7.41	8.69
F		3.11	3.91	4.88	5.91	6.88	7.91	9.25	10.31	11.56	12.59	13.88	16.09
G		.09	.06	.06	.13	.22	.13	.20	.22	.28	.22	.91	1.25
O		2.36	3.05	3.97	4.88	5.63	6.50	7.75	8.50	9.50	10.50	11.63	13.50
Rough Stock Bore		-	-	-	-	-	-	2.09	2.25	2.25	2.75	3.00	4.00
Weight Solid Hubs (LBS)	(3)	9	18	30	59	83	131	200	268	386	465	645	988
Grease	Weight (LB-OZ.)	0-.6	0-1.2	0-2.5	0-3.3	0-4.8	0-11.5	0-13.5	1-5.5	1-13.5	2-8.3	3-14	5-3
	Volume (Pints)	.03	.03	.13	.30	.43	.75	.90	1.5	2.0	2.7	2.8	5.6

Notes:

- (1) Maximum speed without dynamic balancing 60% of values shown. Speed limits are recommendations based on experience and are intended as a guide only. Maximum speed values for floating shaft couplings and for speeds higher than those listed consult SCI.
- (2) Load ratings / torque capacities are based on full 1° misalignment per gear mesh. Selection service factors are required. See Data Sheet DS110.
- (3) Weights are for flex rigid couplings. Weights are approximate.
- (4) Lubrication values are for flex rigid couplings.
- (5) Maximum angular misalignment 1 1/2° per gear mesh. For optimum performance, combined angular and offset misalignment should not exceed 3/4° per gear mesh. Application requirements in excess of 3/4° misalignment per flex half coupling should be referred to SCI.
- (6) Floating shaft length = Distance between shaft ends ÷ 2(C1)
- (7) Sizes 5½, 6 and 7 not available in shrouded bolt.



INDUSTRIAL MAGZA
DIST. AUTORIZADO

MEX (55) 53 63 23 31 MTY (81) 83 54 10 18
QRO (442) 1 95 72 60 ventas@industrialmagza.com

POWERTORK®

DATA SHEET DS108 REV. 03

Series "F" Full Flex Heavy Duty Flange Type Gear Coupling. (Sizes 16 to 30)

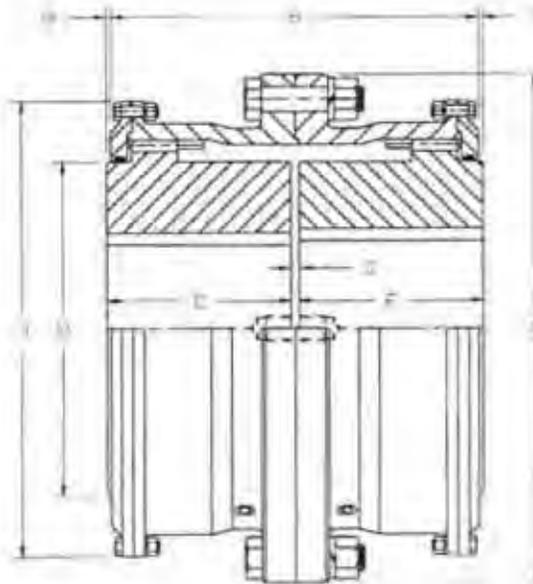

Series F	Size	16	18	20	22	24	26	28	30
Rating (HP/100 RPM)		16150	21150	28850	38200	42500	53000	66000	80500
Torque Capacity (IN-LBS x 10 ³)		10179	13330	18183	24076	26786	33403	41597	50735
Maximum Speed (RPM)	(1)	750	500	400	300	200	200	200	200
Flex Hub	Maximum Bore	22.50	25.75	27.75	30.50	33.75	37.25	40.50	44.00
	Standard Keyway	6 x 2	6 x 2	7 x 2-1/2	7 x 2-1/2	8 x 3	8 x 3	8 x 3	8 x 3
	Maximum Bore	24.00	27.25	29.25	32.00	35.75	39.25	42.50	46.00
	Reduced Depth Keyway	6 x 1-1/4	6 x 1-1/4	7 x 1-3/4	7 x 1-3/4	8 x 2	8 x 2	8 x 2	8 x 2
Parallel Offset Capacity		.247	.256	.304	.334	.361	.382	.390	.395
A		43.00	47.25	53.50	59.00	64.25	68.50	73.75	78.00
B		35.00	36.13	42.38	46.00	49.50	53.00	54.25	55.25
C		1.00	1.00	1.00	1.00	1.00	1.00	1.00	1.00
E		17.38	18.00	21.13	23.00	24.75	26.50	27.13	27.63
F		38.88	43.13	48.38	52.88	57.38	61.63	66.19	70.69
G		.38	.44	.44	.50	.50	.50	.50	.50
O		29.50	33.50	37.00	40.50	45.00	49.00	53.00	57.00
Rough Stock Bore	(5)	13.0	15.0	17.0	19.0	21.0	23.0	25.0	27.0
Weight Solid Hubs (LBS)	(2)	9600	12800	18500	23300	30000	37200	44300	52000
Grease	Weight (LB-OZ.)	75	90	125	150	175	190	210	225
	(3) Volume (Pints)	80	96	134	161	187	203	225	241

Notes:

- (1) Speed limits are recommendations based on experience and are intended as a guide only. Consult SCI for speeds higher than those listed.
- (2) Weights are for full flex couplings. Weights are approximate.
- (3) Lubrication values are for full flex couplings.
- (4) Maximum angular misalignment 1/2° per gear mesh.
Applications in excess of 1/2° misalignment per flex half coupling should be referred to SCI.
- (5) For smaller minimum bore sizes consult SCI.
- (6) Refer to Data Sheet DS110 for service factors.
- (7) Refer to reverse side of data sheet for sizes 8 to 15.



MAGZA
DIST. AUTORIZADO

MEX (55) 53 63 23 31 MTY (81) 83 54 10 18
ORO (442) 1 95 72 60 ventas@industrialmagza.com

POWERTORK®

DATA SHEET DS108 REV. 03

Series "F" Full Flex Heavy Duty Flange Type Gear Coupling.

(Sizes 8 to 15)

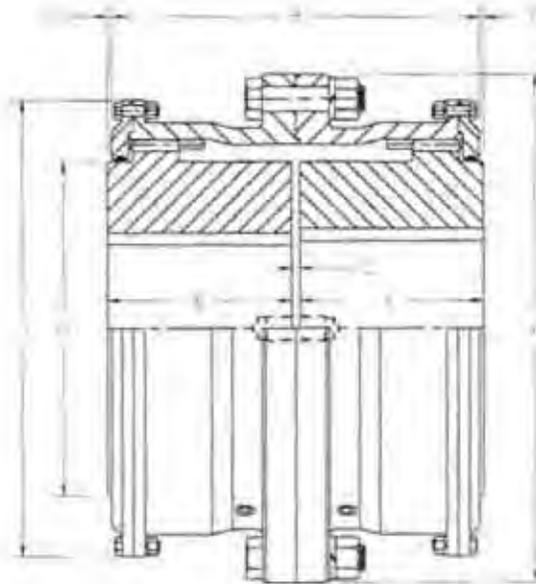

Series F	Size	8	9	10	11	12	13	14	15
Rating (HP/100 RPM)		2250	3200	4375	5800	7200	9050	11100	13500
Torque Capacity (IN-LBS x 10 ³)		1418	2017	2757	3656	4538	5704	6996	8508
Maximum Speed (RPM)	(1)	1750	1625	1500	1375	1250	1125	1000	875
Flex Hub	Maximum Bore	10.75	12.25	13.50	15.00	16.50	18.00	19.25	21.25
	Standard Keyway	2-1/2 x 7/8	3 x 1	3-1/2 x 1-1/4	3-1/2 x 1-1/4	4 x 1/2	4 x 1/2	5 x 1-3/4	5 x 1-3/4
	Maximum Bore	11.00	12.75	14.13	16.00	17.50	18.50	20.25	22.00
	Reduced Depth Keyway	2-1/2 x 5/8	3 x 3/4	3-1/2 x 7/8	4 x 1	4 x 1	5 x 1-1/4	5 x 1-1/4	5 x 1-1/4
Parallel Offset Capacity		.140	.155	.174	.190	.200	.209	.222	.235
A		23.25	26.00	28.00	30.50	33.00	35.75	38.00	40.50
B		19.50	21.75	24.00	26.25	27.75	29.50	31.25	33.13
C		.38	.50	.50	.50	.50	.75	.75	.75
E		9.81	10.88	12.00	13.13	13.88	14.63	15.50	16.50
F		20.50	23.00	25.13	27.31	29.81	32.00	34.13	36.75
G		.25	.25	.25	.25	.25	.25	.25	.31
O		14.00	16.00	18.00	20.00	21.75	23.50	25.50	27.50
Rough Stock Bore	(5)	5.0	6.0	7.0	8.0	9.0	10.0	11.0	12.0
Weight Solid Hubs (LBS)	(2)	1650	2200	3000	3550	4500	5750	7000	8400
Grease	Weight (LB-OZ.)	14	24	28	38	43	47	55	82
	Volume (Pints)	15	26	30	41	46	50	59	66

Notes:

- (1) Speed limits are recommendations based on experience and are intended as a guide only. Consult SCI for speeds higher than those listed.
- (2) Weights are for full flex couplings. Weights are approximate.
- (3) Lubrication values are for full flex couplings.
- (4) Maximum angular misalignment 1/2° per gear mesh.
Applications in excess of 1/2° misalignment per flex half coupling should be referred to SCI.
- (5) For smaller minimum bore sizes consult SCI.
- (6) Refer to Data Sheet DS110 for service factors.
- (7) Refer to reverse side of data sheet for sizes 16 to 30.



MAGZA
DIST. AUTORIZADO

MEX (55) 53 63 23 31 MTY (81) 83 54 10 18
QRO (442) 1 95 72 60 ventas@industrialmagza.com

POWERTORK®

Series "F" Full Flex Flange Type Gear Coupling.

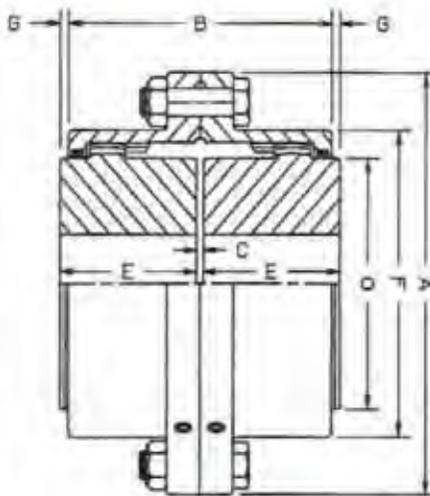

Full Flex
Standard Mount

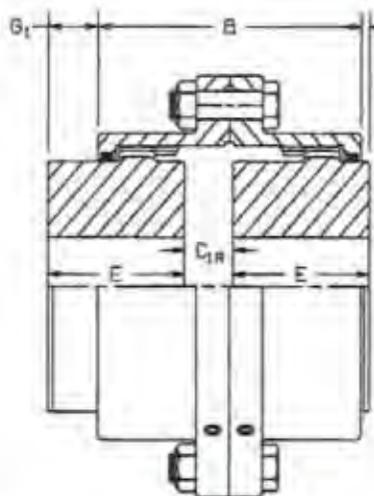

Full Flex
One Hub Reversed

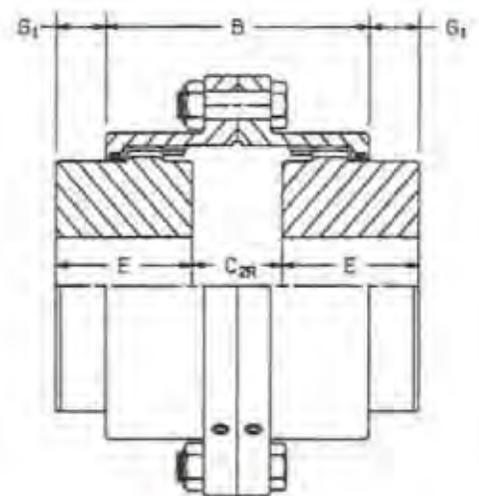

Full Flex
Two Hubs Reversed

Series F	Size	1	1½	2	2½	3	3½	4	4½	5	5½	6	7
Rating (HP/100 RPM)		15.5	31	51	90	152	240	380	500	710	925	1200	1850
Torque Capacity (IN-LBS x 10³)		9.77	19.5	32.1	56.7	96	151	240	315	447	583	756	1166
Maximum Speed (RPM)	(1)	10800	8800	8300	7670	7150	6330	5670	5160	4650	4350	3820	3150
Flex Hub	Maximum Bore	1.63	2.13	2.75	3.50	4.00	4.50	5.50	6.00	6.88	7.75	8.75	10.38
	Standard Keyway	3/8 x 3/16	1/2 x 1/4	5/8 x 5/16	7/8 x 7/16	1 x 1/2	1 x 1/2	1-1/4 x 3/8	1-1/2 x 3/4	1-3/4 x 3/4	2 x 3/4	2 x 3/4	2-1/2 x 7/8
	Maximum Bore	1.75	2.31	2.88	3.75	4.38	5.00	5.88	6.50	7.13	8.00	9.00	10.63
	Reduced Depth Keyway	3/8 x 5/8	5/8 x 3/16	3/4 x 3/16	7/8 x 2/16	1 x 5/16	1-1/4 x 3/8	1-1/2 x 1/2	1-1/2 x 1/2	1-3/4 x 3/8	2 x 5/8	2 x 3/8	2-1/2 x 3/4
Parallel Offset Capacity		.056	.069	.089	.108	.126	.153	.176	.201	.229	.256	.255	.301
	A	4.56	6.00	7.00	8.38	9.44	11.00	12.50	13.63	15.31	16.75	18.00	20.75
	B	3.31	3.88	4.84	5.00	6.94	8.38	9.34	10.50	11.81	13.13	13.31	15.25
	C	.13	.13	.13	.19	.19	.25	.25	.31	.31	.31	.31	.38
	C1R	.44	.72	.94	1.09	1.28	1.72	1.97	2.38	2.72	3.16	2.34	2.81
	C2R	.75	1.31	1.75	2.00	2.38	3.19	3.69	4.44	5.13	6.00	4.38	5.25
	E	1.69	1.94	2.44	3.03	3.59	4.19	4.75	5.31	6.03	6.63	7.41	8.69
	F	3.11	3.91	4.88	5.91	6.88	7.91	9.25	10.31	11.56	12.59	13.88	16.09
	G	.09	.07	.08	.13	.22	.13	.20	.22	.28	.22	.91	1.25
	G1	.41	.66	.89	1.03	1.31	1.59	1.92	2.28	2.69	3.06	2.94	3.69
	O	2.36	3.05	3.97	4.88	5.63	6.50	7.75	8.50	9.50	10.50	11.63	13.50
Rough Stock Bore		-	-	-	-	-	-	2.09	2.25	2.25	2.75	3.00	4.00
Weight Solid Hubs (LBS)	(3)	9	18	30	59	83	131	200	268	386	465	645	988
Grease Weight (LB-OZ.)		0-1.1	0-2.3	0-5	0-6.5	0-9.5	1-7	1-11	2-11	3-11	5-5	7-12	10-5
(4) Volume (Pints)		.06	.06	.25	.60	.86	1.5	1.8	2.9	4.0	5.4	8.2	11.2

Notes:

- (1) Maximum speed without dynamic balancing 60% of values shown. Speed limits are recommendations based on experience and are intended as a guide only. Consult SCI for speeds higher than those listed.
- (2) Load ratings / torque capacities are based on full 1" misalignment per gear mesh. Selection service factors are required. See Data Sheet DS110.
- (3) Weights are for full flex couplings. Weights are approximate.
- (4) Lubrication values are for full flex couplings.
- (5) Maximum angular misalignment 1 1/2" per gear mesh. For optimum performance, combined angular and offset misalignment should not exceed 3/4" per gear mesh. Application requirements in excess of 3/4" misalignment per flex half coupling should be referred to SCI.
- (6) Sizes 5½, 6 and 7 not available in shrouded bolt.

POWERTORK[®] Flange Type Gear Couplings

Specified by major O.E.M.'s and industrial users, flange type couplings designed and manufactured by System Components, Inc. are installed on a wide range of drive applications.

A strong rugged coupling that meets demanding performance and quality requirements, making POWERTORK[®] a natural for industrial power transmission applications. Here are some of the key Features and Advantages.

Features

- o High Misalignment Capability
- o Large Inventory of Stock Couplings
- o Larger Sizes Available
- o Interchangeability
- o Other Types Available
- o Ease of Lubrication

Advantages

Up to +/- 3° Angular misalignment.

Full Flex, Flex Rigid and Rigid Rigid stock available in sizes 1-F through 7-F accommodating bore sizes to 13 1/8".

All Coupling configurations available up to size 30-F accommodating bore sizes up to 46".

Flanges manufactured to industry standards permitting flange to flange interchangeability with other manufacturers.

Includes cut-out, overload release type with shear pin, slide, breakwheel, double engagement, continuously lubricated, spindle, high speed, high performance and insulated couplings. See pages F-14 to F-16.

Facilitated by two lubrication pipe plugs 180° apart in each sleeve permitting assemblies having a lube hole every 90°.

An Introduction to System Components, Inc. and Couplings with Clear Competitive Advantages

Since 1967, System Components, Inc. has specialized in providing a select range of the highest quality couplings for *non-automotive power* transmission applications. This catalog profiles our standard products and the many refinements and advantages they offer compared to competing products. But may we also point out the many *other* reasons why our customers have elected to deal with our company . . . many for longer than 25 years?

One key reason is our willingness and ability to custom-modify our standard products or custom-engineer a special product to meet specific application requirements.

Another is that, as a relatively small, specialty company, we can be more responsive to customer requests for product information, technical assistance, design assistance, and quotations. Since we are not a "*power transmission superstore*", our personnel are more intimately familiar with the application of our products for optimum solutions. Plus, because we deal with a smaller number of customers than the giants, our staff has more time to make sure all your requests are handled more promptly.

Yet another reason is our reputation for competitive pricing. Again, by remaining a specialist, we have been able to develop more efficient manufacturing and assembly systems than those responsible for a much wider range of products. Also, we do not bear the heavy overhead costs of our much bigger competitors. In the product categories where we compete, we are consistently able to meet or beat our competitor's price . . . even as we deliver distinct product quality enhancements.

Of course the number one reason our customers remain our customers is because they have compared our products to others and found them superior. In fact, many have reported SCI components have been operating trouble-free for more than a decade. Here is a brief review of the many small refinements engineered into our couplings that result in a big quality and performance advantage for our customers.