



DISTRIBUIDOR
AUTORIZADO

MEX (55) 53 63 23 31
QRO (442) 1 95 72 60

MTY (81) 83 54 10 18

ventas@industrialmagza.com

PP143 US

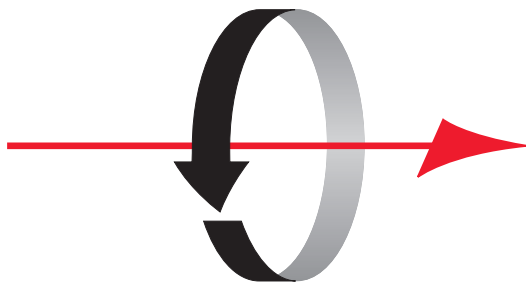

DEUBLIN®

Engineered for Performance

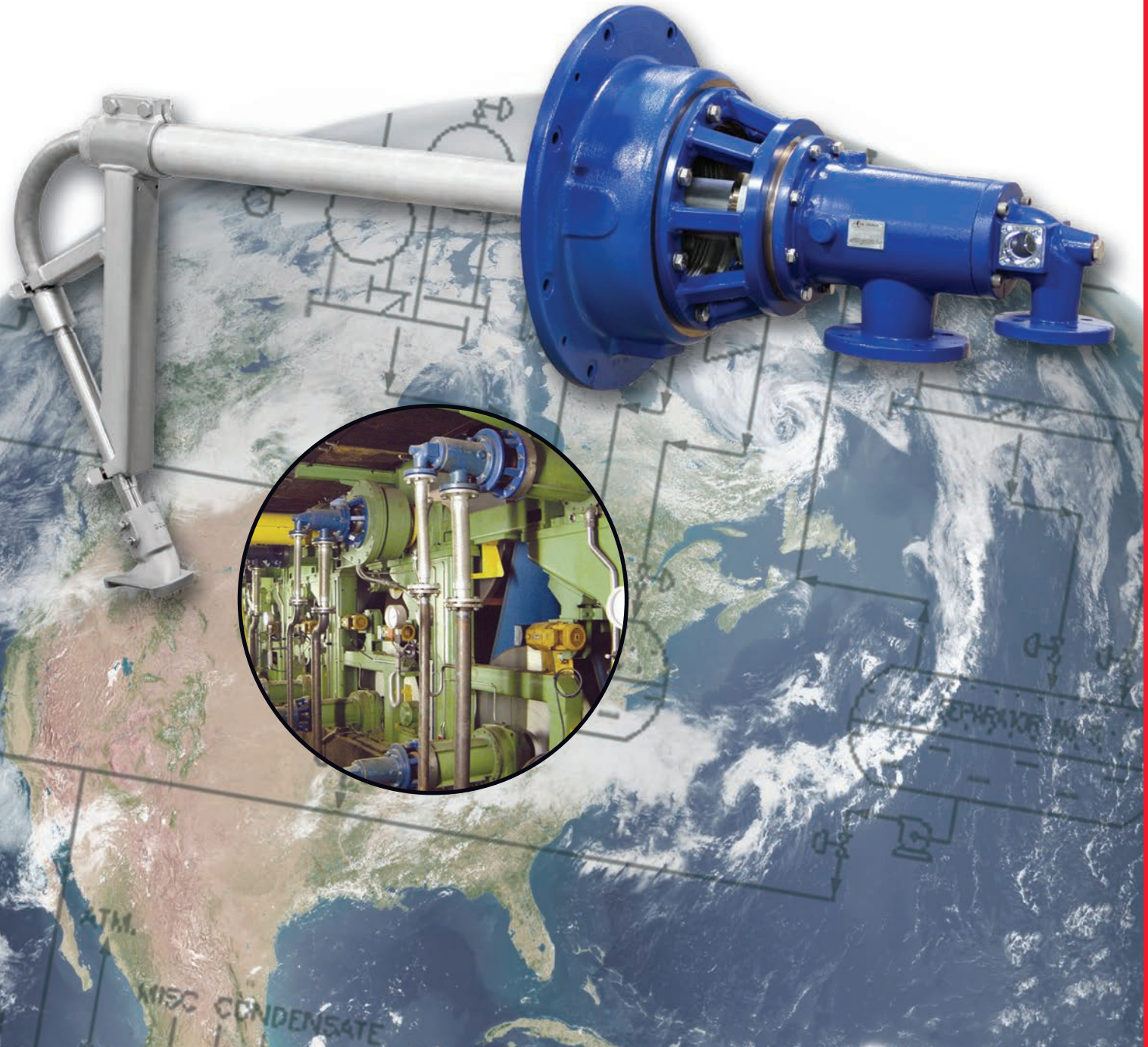

ROTATING JOINTS AND SIPHON SYSTEMS

For The Paper Industry

www.deublin.com

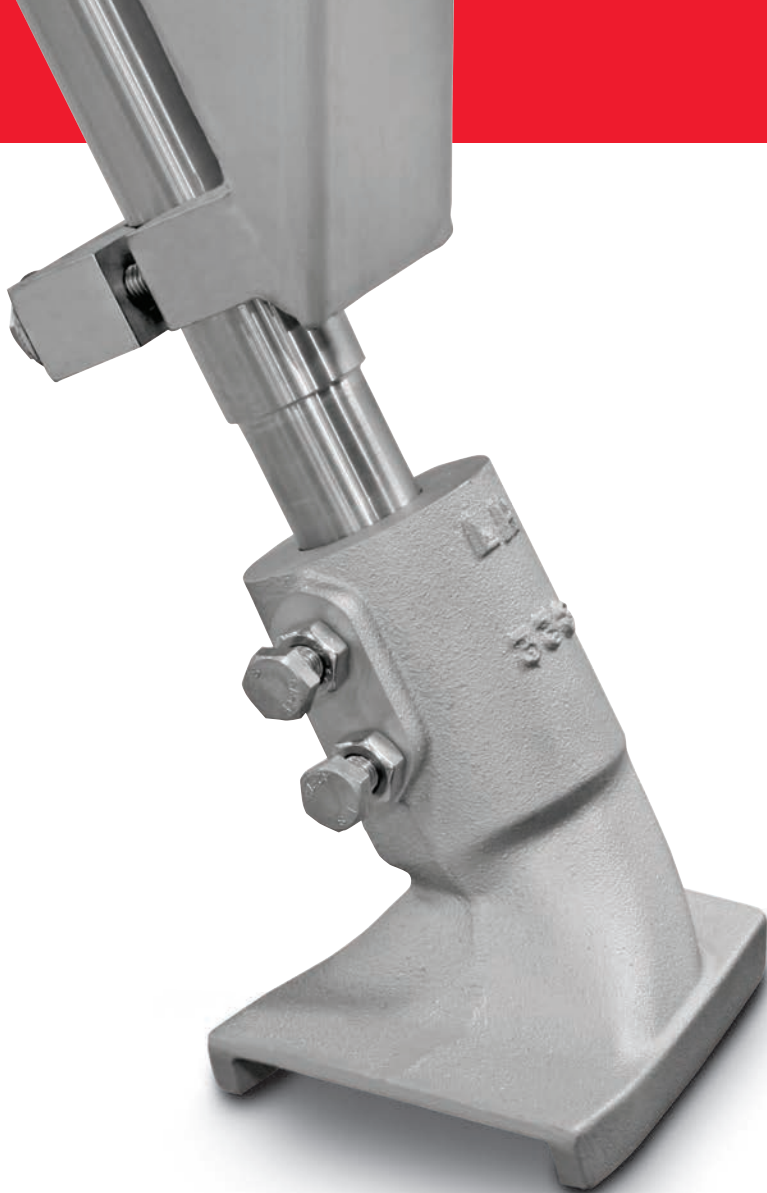

Effective solutions for optimizing paper machine steam systems and dryer sections.

As fuel costs rise, paper producers focus on maximizing machine efficiency. Considering that the dryer section is the largest consumer of steam energy in a paper machine – typically accounting for 55% of the total machine energy cost – an optimized steam and condensate system increases production capability and improves machine efficiency, leading to lower drying costs and increased profits.

Dryer optimization solutions therefore focus on steam system and condensate removal technologies, encompassing rotating steam joints, stationary and rotating siphons and allied components that work together to:

- Reduce differential pressure, decreasing or eliminating the need for high-pressure motive steam, resulting in dramatic energy savings
- Reduce blow-through steam and hardware erosion
- Eliminate dryer flooding
- Free operators from dealing with steam system deficiencies
- Reduce requirements for energy-intensive steam by improving system efficiency and eliminating venting
- Reduce the operational impact of sheet breaks and improve overall system reliability
- Enhance product quality by improving drying uniformity and reducing sheet picking

Since no single system is universally effective, *DEUBLIN* offers a variety of steam joint and siphon systems to ensure maximum performance of today's high-speed paper machines under varied operating conditions.



DELTASINT™



SL™



ECOSINT™



ROTOSINT™ STD



ELBOW

SIPHON SELECTION CHART

The selection chart below is for reference only. Consult *DEUBLIN* Engineering for assistance in the actual selection of a siphon system.

		SPEED													
		MPM	100	200	300	400	500	600	700	800	900	1000	1100	1200	1300>
		FPM	330	660	980	1310	1640	1970	2300	2620	2950	3280	3610	3940	4270>
Deltasint	Stationary	[Bar chart showing Deltasint Stationary siphons available from 100 to 1300+ MPM]													
SL	Stationary	[Bar chart showing SL Stationary siphons available from 100 to 700 MPM]													
Rotosint	Rotating	[Bar chart showing Rotosint Rotating siphons available from 300 to 600 MPM]													
Ecosint	Rotating	[Bar chart showing Ecosint Rotating siphons available from 100 to 400 MPM]													
SRS Elbow	Stationary	[Bar chart showing SRS Elbow Stationary siphons available from 100 to 300 MPM]													

SIPHONS & STEAM JOINTS INDEX

	APPLICATION	PAGE	PRODUCT	DESCRIPTION
SIPHONS	Paper machines, any speed	4-5	DELTASINT SIPHONS	Cantilevered stationary siphon
	Paper machines, open gear up to 150 MPM (500 FPM)	6	SRS ELBOW SIPHONS	Steam joint supported
	Paper machines, open gear, up to 700 MPM (2300 FPM)	7	SL SIPHONS	Stationary siphons
	Paper machines, 250 to 610 MPM (820 to 2000 FPM)	7	RTOSINT SIPHONS	Rotating siphons
	Paper machines, up to 400 MPM (1310 FPM)	7	ECOSINT SIPHONS	Rotating siphons
	Cooling and swing cylinders	10	SIPHONS FOR COOLING SYSTEMS & SWING CYLINDERS	–
STEAM, HOT OIL & WATER JOINTS	Paper machines-enclosed gear, any speed, Deltasint Stationary Siphon	4	FSU SERIES STEAM JOINTS	Bell or bracket-mounted; balanced mechanical seals
	Paper machines-open gear, stationary or rotating siphon	6	H SERIES STEAM JOINTS	Self-supported; pressure type joint
	Paper machines-open gear, up to 900 MPM, (3000 FPM) Deltasint Stationary Siphon	8	FSB SERIES STEAM JOINTS	Self-supported (ball-bearings); balanced mechanical seals
	Yankee Dryers	8	FG SERIES STEAM JOINTS	Bell-mounted or balanced mechanical seals
	Paper machines-enclosed gear, medium speed, rotating siphon	9	DMS SERIES STEAM JOINTS	Bell or bracket-mounted; dual balanced mechanical seals
	Bellows-type seal replacement	9	CCK	Cartridge conversion kit
	Press rolls and swing cylinders	10	F SERIES COOLING SYSTEM & FSU SERIES JOINTS	Self-supported (ball bearings); balanced mechanical seals
	Calender Stacks	11	6000 & F SERIES ROTATING UNIONS	Self-supported (ball bearings); balanced mechanical seals
	Calender, Soft Nip	11	CK ROTATING UNIONS	Self-supported; balanced mechanical seals
	Paper machines-medium & high speed	12	TURBULENCE BARS	–
–	13	WARRANTY & REPAIR	–	
–	14-16	DEUBLIN STEAM SYSTEMS SERVICES	–	

CONDENSATE BEHAVIOR AT VARIOUS SPEEDS



PUDDLING



LIGHT CASCADING



CASCADING



RIMMING

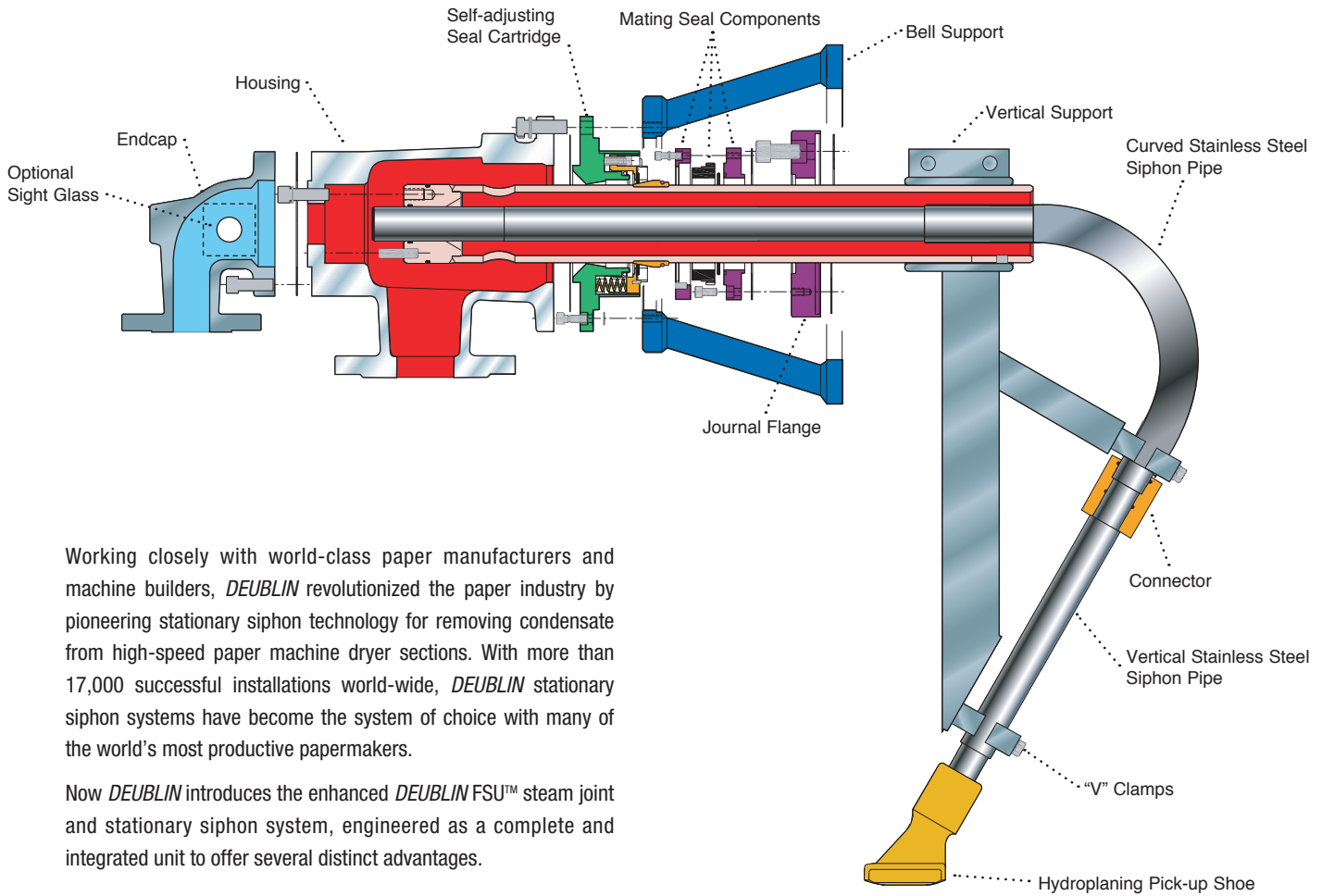

Working closely with world-class paper manufacturers and machine builders, *DEUBLIN* revolutionized the paper industry by pioneering stationary siphon technology for removing condensate from high-speed paper machine dryer sections. With more than 17,000 successful installations world-wide, *DEUBLIN* stationary siphon systems have become the system of choice with many of the world's most productive papermakers.

Now *DEUBLIN* introduces the enhanced *DEUBLIN FSU™* steam joint and stationary siphon system, engineered as a complete and integrated unit to offer several distinct advantages.

Deltasint Stationary Siphon System Features and Benefits

Features	Benefits
Unitized, flat-faced balanced mechanical seal	<ul style="list-style-type: none"> • Quickly and easily installed or replaced, reducing downtime and labor • Reduces contact pressure on the carbon face, resulting in longer seal life (3 years plus) • Seal ring indicator provides visual inspection for preventative maintenance
60° stationary siphon position outside sheet edge	<ul style="list-style-type: none"> • Eliminates wet edges • Allows use of full-length turbulence bars for improved sheet moisture at the reel
Two widely-spaced cylindrical and conical supports	<ul style="list-style-type: none"> • Increased siphon rigidity, minimize vertical deflection of stationary siphon
Hydroplaning pick-up shoe	<ul style="list-style-type: none"> • Rimming condensate creates upward lift resulting in third supporting point • Increases stiffness, minimizes siphon vibration, prevents pick-up shoe-to-shell contact



• **Immune to centrifugal force effects**

Unlike a rotating siphon, a stationary siphon is not affected by the centrifugal force of the rotating dryer. It will remove condensate even at a differential pressure of less than 2 psi, without risking dryer flooding.

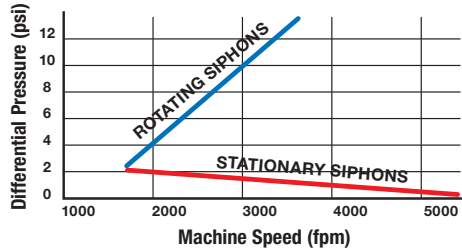

• **Improved heat profile control for better product quality**

Picking and related problems can be a result of high differential pressures. When the dryer’s surface is too hot for the moisture content of the sheet, it flashes – then picks, drags and flutters out of control. Eliminating the need for high differential pressure enables better control of dryer surface temperature by adjusting the steam pressure to match the drying cycle of the different paper grades. The FSU System restores control of dryer heat profile and product quality across a wide range of paper grades.

• **Improved moisture profile**

The FSU has a standard 60° siphon configuration that places the siphon outside the sheet edge, eliminating edge profile problems by improving the dryer temperature profile. Stubborn moisture problems are typically cured by removing the front-end siphon, installing turbulence bars and replacing the backside siphon with a dual flow FSU system.

• **Eliminates “start-up” with flooded dryers**

Because the FSU stationary system is fixed in the 6 o’clock position, dryer flooding caused by improper positioning of rotary siphons is eliminated.

• **Unitized, flat-faced balanced mechanical seal**

Designed for quick and easy installation or replacement to reduce downtime, the balanced mechanical seal extends seal life up to three years or more by reducing contact pressure on the carbon face. A seal ring wear indicator enables visual inspection to cue preventive maintenance.

• **Rigid, stable support system**

Two widely-spaced cylindrical and conical supports comprise a firm cantilever design with increased rigidity to minimize vertical deflection.

• **Hydroplaning pick-up shoe**

The unique shoe design prevents shoe-to-shell contact by hydroplaning on the rimming condensate, maintaining close clearance for effective condensate removal at any speed. The hydroplaning action also produces upward pressure that acts as a third support point and reduces vibration.

• **No moving parts**

Simple, robust design extends operating time and reduces maintenance.

• **Keep pace with increasing machine speeds**

With rotating siphons, higher speeds demand higher differential pressure, which produces more blow-through steam, resulting in higher bi-phase velocity. This increases wear and premature failure of the condensate hardware. The DEUBLIN FSU stationary siphon system solves the problem!

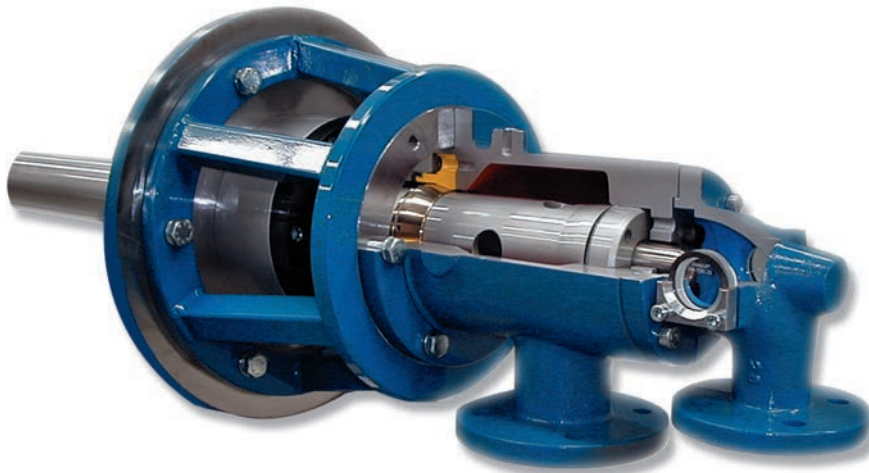

OPERATING DATA		
MAX PRESSURE	160 PSI	11 BAR
MAX TEMPERATURE	400°F	205°C
MAX SPEED	400 RPM	400/MIN

H SERIES STEAM AND HOT OIL UNIONS

The H Series is DEUBLIN'S most popular self-supported rotating pressure joint, engineered specifically for steam and hot oil applications common in the paper, plastic and textile industries.

Especially suited for open gear machines, where external mounting surfaces are not available, the self-supporting design of the H Series features two widely-spaced, self-aligning carbon graphite bearings that distribute the load more evenly, reducing wear and promoting longer seal life. The high nickel and chromium content of the Ni-Resist seals provides an excellent sealing surface and resists wear due to corrosion and abrasion. The sealing surfaces can be easily reconditioned with an emery cloth.

The sealing mechanism is designed such that the carbon graphite is under compression. Carbon graphite under compression is four times stronger than in tension, so it can better withstand pressure surges and water hammering. The convex seal ring is also better suited to handle mechanical and thermal shock. Two threaded plugs (optional) in the housing located over the carbon graphite seals allow for monitoring of seal face wear.

The H Series is available in either monoflow or duoflow configuration, with flanged or threaded stainless steel rotor. The end cap of the duo-flow version for steam service with a rotating siphon is available with dual sight glasses to monitor condensate flow.

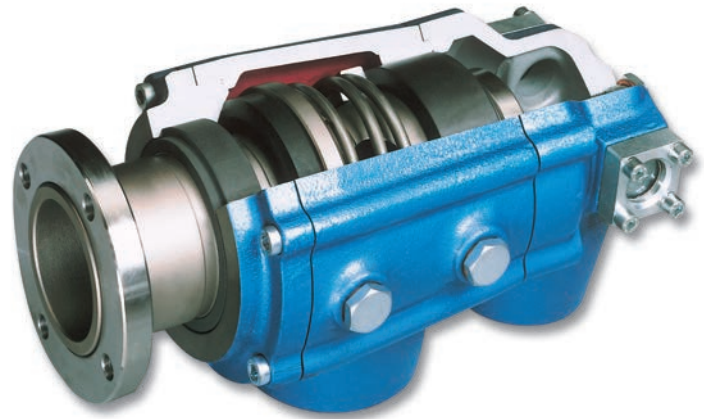

OPERATING DATA

MAX SAT. STEAM PRESSURE	150 PSI	10 BAR
MAX SPEED SAT. STEAM SERVICE	180 RPM	180/MIN
MAX SAT. STEAM TEMP.	365°F	185°C
MAX HOT OIL PRESSURE	100 PSI	7 BAR
MAX SPEED HOT OIL SERVICE	350 RPM	350/MIN
MAX HOT OIL TEMP.	450°F	232°C



SRS siphon is recommended for use with the Deublin H Series self-supported steam joint.

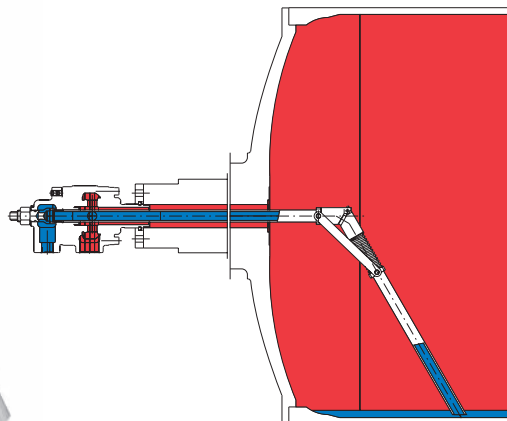

SRS™ STATIONARY SIPHON FOR SPEEDS UP TO 150 MPM (500 FPM)

The SRS™ elbow stationary siphon is installed from the outside and requires no adjustments or positioning from the inside of the dryer. It is thus applicable to dryers without manholes. The knuckle forming the elbow is constructed from stainless steel joined by a pin. In addition, the spring maintains a fixed vertical position. Its uniform internal diameter eliminates flow restriction. Elbow stationary siphons can be used with DEUBLIN H or HS Series steam joints with S type inner bushings.

The SRS elbow stationary siphon is furnished with a support to the horizontal pipe inside the dryer, thus reducing the cantilevered length of the horizontal pipe, dampening siphon vibration and increasing siphon and steam joint life. In addition, the siphon can be positioned closer to the dryer shell, thereby improving heat transfer. The support and siphon are installed from the outside.

SL™ STATIONARY SIPHONS FOR SPEEDS UP TO 700 MPM (2300 FPM)

The SL™ is designed for low-speed open gear machines in which the typical condensate behavior is puddling or light cascading. The system is installed inside the dryer (thus requiring manhole access to the dryer cylinder) using a head-mounted spider support, which utilizes an internal bushing to buttress the horizontal siphon pipe. The vertical pipe is joined by means of a heavy-duty reinforced 90° elbow that provides additional rigidity.

The special pick-up shoe has a PTFE sole to prevent damage in the unlikely event of contact with the dryer shell. The rigid mounting and protective PTFE sole enable positioning of the shoe closer to the shell of the dryer, thus ensuring effective condensate removal with minimal differential pressure and blow-through. The SL stationary siphon is recommended for use in open gear machines with the DEUBLIN H Series self-supported steam joint.



Typical installation of SL Stationary Siphon.

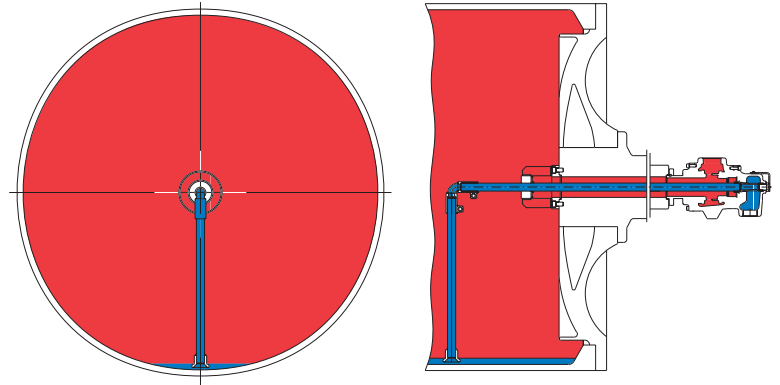

For lower speed ranges (cascading condensate) a special 180° discharge pipe is available and acts as a trap to reduce the amount of blow-through as the pick-up shoe rotates outside the condensate puddle.

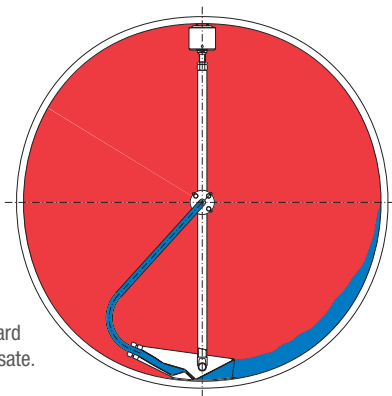

Typical Ecosint application with standard discharge pipe and cascading condensate.

ECOSINT™ ROTATING SIPHONS FOR SPEEDS TO 400 MPM (1310 FPM)

The Ecosint™ pick-up shoe is similar to the scoop-type siphon that was traditionally cast into the dryer head. The wide scoop-like frontal opening of the shoe is ideally suited for machines operating at speeds that promote puddling and initial rimming behavior of the condensate – conditions at which the condensate ramps over a narrow dryer circumference. The wide opening profile maximizes condensate evacuation during the relatively short time it rotates through the condensate layer.

RTOSINT™ ROTATING SIPHONS FOR SPEEDS FROM 250 TO 610 MPM (820 TO 2000 FPM)

The Rotosint™ siphon features close shoe clearance to provide efficient condensate evacuation around its entire circumference. This system also uses a spider-type support, bolted to the head of the dryer.





FSB™ SERIES STEAM JOINTS

Pioneered by DEUBLIN, the FSB™ is a self-supported steam joint that features ball bearings and a balanced mechanical seal applicable to (in tandem with a stationary siphon) high-speed open gear machines. With the FSB, many older open gear machines may now be upgraded to utilize stationary siphons that offer the benefits of reduced differential pressure and blow-through. When teamed up with a stationary siphon, the FSB Series steam joint offers an opportunity to increase production on dryer limited machines while reducing downtime and maintenance costs.

The FSB steam joint/stationary siphon combination is suitable for machine throughput speeds up to 900 MPM (3000 FPM) with a steam pressure of 3 bar (45 PSI).

The balanced mechanical seal delivers improved seal life by up to four times that of conventional pressure-type seals (depending upon steam pressure, speed and paper grade.)

OPERATING DATA

MAX PRESSURE	45 PSI	3 BAR
MAX TEMPERATURE	250°F	120°C
MAX SPEED	200 RPM	200/MIN

(NOTE: Adjusting the drying capacity of the paper machine may require shutting off the steam flow to certain dryers. However, since steam serves as a lubricant for the seal faces, shutting off steam flow amounts to running the seal faces dry, which will lead to premature wear and failure of the seals.)

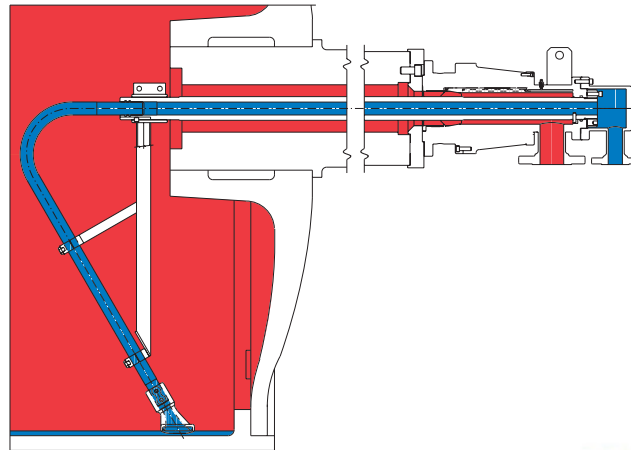

FG™ SERIES JOINTS

Designed specifically for Yankee Dryers, FG™ Series joints are externally supported, with the seal ring assembly attached to the rotating cylinder journal, while the counter seal is attached to the stationary joint body. The joint body is rigidly secured to the machine frame by a bell, bracket or rod support.

While pressure-type joints use operating pressure to maintain sealing, FG Series joints use mechanical seals to lower seal contact pressure and thus reduce wear and extend seal life, even under high-pressure conditions. Seal wear is fully compensated through provisions for axial movement of internal seal components. The joint body remains fixed throughout the life of the seal.

The FG series will also accommodate dryers fitted with CARB* bearings.

*SKF Trademark



OPERATING DATA

MAX PRESSURE	150 PSI	10 BAR
MAX TEMPERATURE	365°F	185°C
MAX SPEED	400 RPM	400/MIN

DMS™ SERIES STEAM JOINTS



The DMS™ Series rotating joint has dual seal assemblies in which the seal ring is attached to the rotor, which is bolted to the rotating journal. The seal ring contacts the counter seal attached to the stationary joint body, which is rigidly secured to the machine frame by an external support and remains fixed throughout the life of the seal.

The DMS also features balanced mechanical seals that operate with reduced contact pressure at the seal faces. This reduces wear and extends seal life. Seal wear is fully compensated automatically through designed axial movement of internal seal components.

Like most *DEUBLIN* joints, the DMS is available in either monoflow (steam supply or condensate return) or duoflow (steam supply and condensate return through a single connection).

The DMS Series steam joint is suitable for enclosed gear, moderate-speed paper machines with rotating siphons.

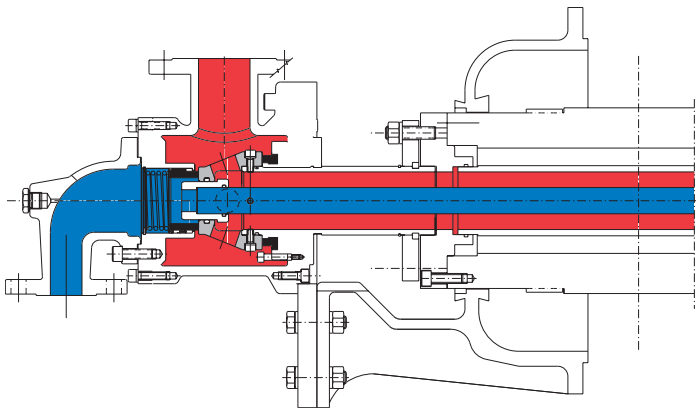

OPERATING DATA

MAX PRESSURE	150 PSI	10 BAR
MAX TEMPERATURE	365°F	185°C
MAX SPEED	400 RPM	400/MIN

CCK™ CARTRIDGE CONVERSION KIT

The CCK™ has been designed as an easy field conversion kit to replace existing bellows type seals. The conversion does not require any piping modification. In addition, the CCK mounts to the existing housing and utilizes the existing end cap and rotating siphon. The CCK features the same seal system as the DMS described above.

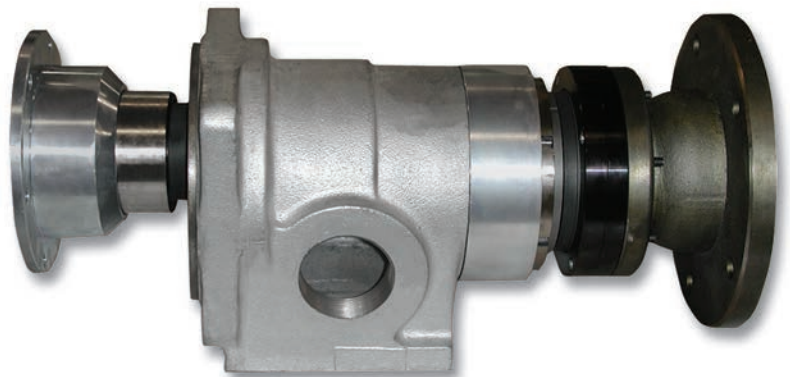

F SERIES COOLING SYSTEM JOINTS

The F Series joints feature a self-supported design. Its rotor is attached by a flange to the rotating cylinder journal, while the joint body is attached to stationary inlet and outlet piping. Two ball bearings support the rotor and allow it to rotate within the joint body.

A bell-supported version is also available.

OPERATING DATA

MAX PRESSURE	200 PSI	14 BAR
MAX TEMPERATURE	250° F	120° C
MAX SPEED	200 RPM	200/MIN

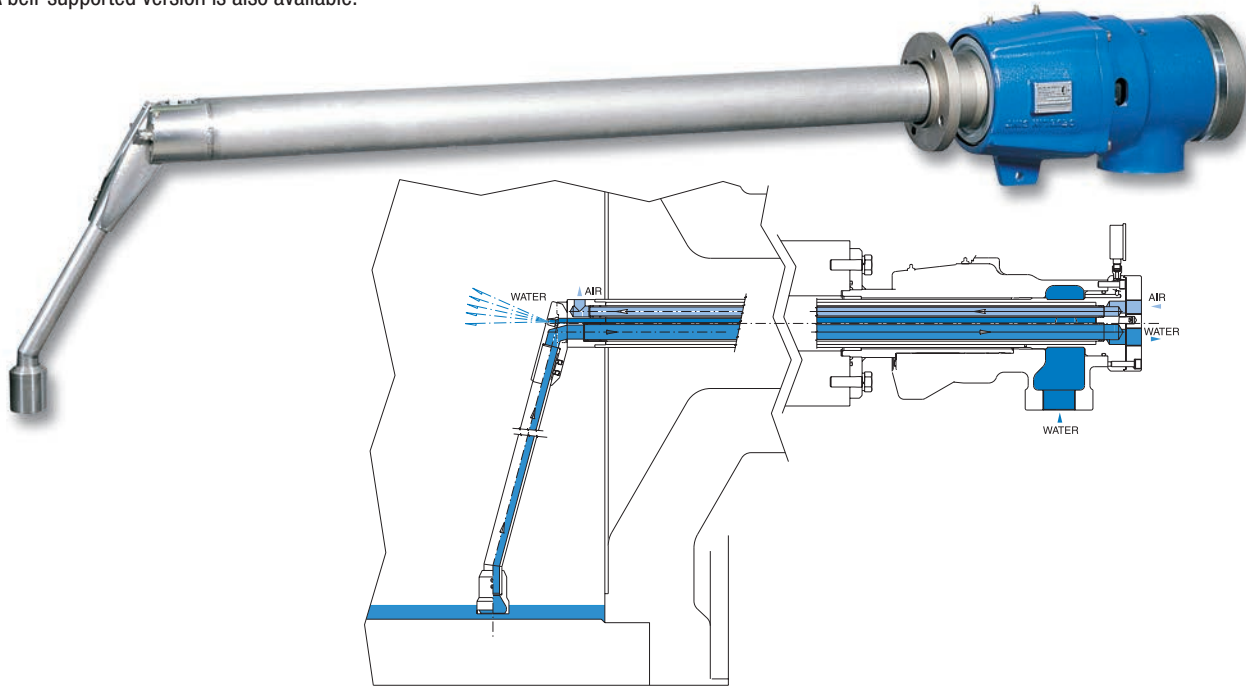

SIPHONS FOR COOLING AND SWING CYLINDERS

The cooling cylinder must reduce the sheet temperature uniformly across the web. To ensure uniform heat reduction, an effective cooling system introduces a mixture of cold water and air to provide the required pressure differential to evacuate the warmer water at a rate that keeps the cylinder's surface temperature constant. Removal of the warm water faces the same conditions as removal of condensate in the dryer section; i.e., like condensate, it puddles, cascades and rims. For these reasons, most of the same siphon systems are equally effective in both heating and cooling applications. *DEUBLIN* also offers systems designed specially for pope reels and press rolls.

Modern paper machines often have dual-purpose (cooling or drying) cylinders. These versatile "swing" cylinders have special requirements to enable them to perform effectively in either mode. *DEUBLIN* has the expertise to furnish a complete stationary or rotating siphon system to meet these requirements.

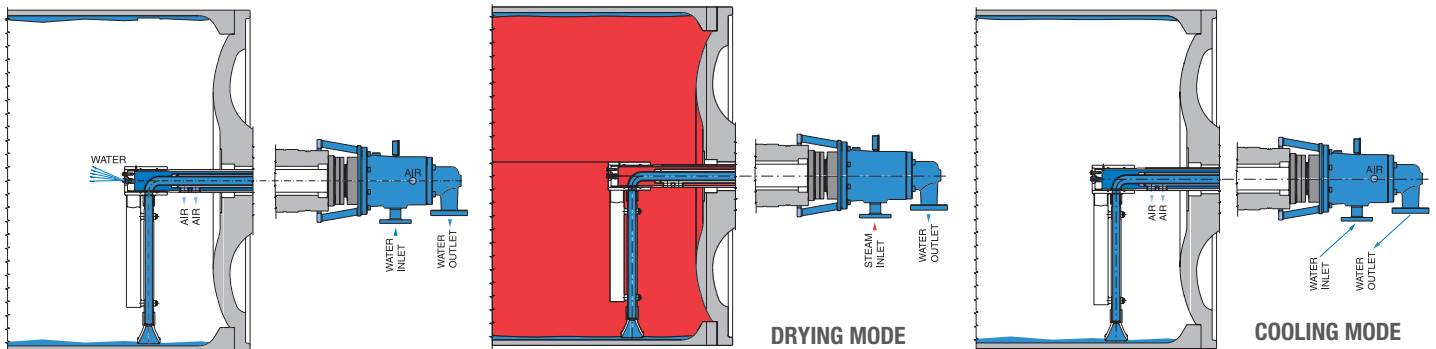

6000 SERIES CARTRIDGE WATER UNIONS

The 6000 Series joint is a self-supported design with the rotor attached to the rotating cylinder by means of a heavy-duty flange, while the joint body is attached to stationary inlet and outlet piping. Dual ball bearings support the housing and allow the rotor to rotate within the joint body, which remains fixed. Sealing is provided by a mechanical seal which uses a flat-faced Carbon Graphite (standard) or Silicon Carbide (ELS) steel-banded floating seal ring that mates against a Tungsten Carbide seal ring face.

The 6000 uses a balanced mechanical seal that hydraulically limits contact pressure on both sealing surfaces. The joint body remains fixed throughout the life of the seal. This reduces seal wear for longer life. Seal wear is fully compensated automatically through provision for axial movement of internal seal components, and seals are designed for quick and easy on-machine replacement.

The 6000 Series is available in monoflow and duoflow configurations.

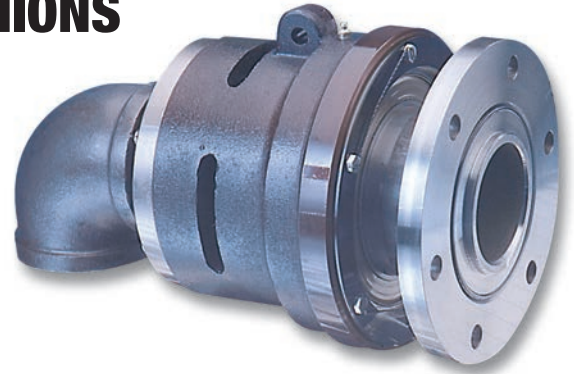

OPERATING DATA

MAX WATER PRESSURE	150 PSI	10 BAR
MAX SPEED FLANGED	750 RPM	750/MIN
MAX TEMPERATURE	250°F	120°C

>250°F (120°C) consult *DEUBLIN*

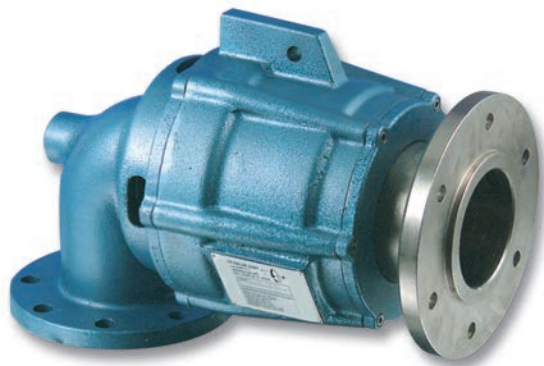

OPERATING DATA

Meets ANSI; optionally DIN, JIS

MAX WATER PRESSURE	150 PSI	10 BAR
MAX SPEED	1,000 RPM	1,000/MIN
MAX TEMPERATURE	250°F	120°C

>250°F (120°C) consult *DEUBLIN*

F SERIES 5" WATER UNION

The F Series features a balanced mechanical seal with Ni-Resist-to-Carbon Graphite seal faces. A spring-reinforced PTFE U-cup is used as a secondary seal between the floating seal and the rotor. A special labyrinth seal between the bearing and the floating seal protects the bearings and prevents media from entering the bearing cavity. For convenience, the union allows on-machine seal replacement.

The F Series also features self-supporting design. The rotor is attached by a heavy-duty flange to the rotating cylinder journal, while the joint body is attached to the stationary inlet and outlet piping. Two widely-spaced ball bearings support the rotor and allow it to rotate within the joint body, while rigidly supporting the housing relative to the rotor. Both the housing and the rotor are nickel-plated to resist corrosion. A bell-supported version is also available.

The F Series is available in monoflow and duoflow configurations. Special designs up to 12 inches (300mm) are available on request.



OPERATING DATA

MAX PRESSURE	85 PSI	6 BAR
MAX TEMPERATURE	450°F	232°C
MAX SPEED	1000 RPM	1000/MIN

CK SERIES JOINTS

The CK Series joint is a self-supported, high temperature design. Its rotor is attached to the rotating cylinder, while the joint body is attached to stationary inlet and outlet piping. An inboard sleeve bushing and an outboard thrust bearing support the housing and allow the rotor to rotate within the joint body. Sealing is provided by balanced mechanical seals, which use flat-faced seal rings that mate against counter faces.

The CK Series relies on mechanical seals that limit contact pressure on the sealing surface. This reduces seal wear for longer seal life. Seal wear is fully compensated through designed axial movement of internal seal components. The joint body remains fixed throughout the life of the seal. All CK Series joints are duoflow units that handle both entering and exiting hot oil.

IMPROVE MOISTURE PROFILE MAXIMIZE HEAT TRANSFER



Puddling

Condensate in full cascade provides the most efficient heat transfer. However, as machine operating speeds increase beyond approximately 305 MPM (1000 FPM), for 1.5 meter (5 feet) diameter dryer, centrifugal force causes the condensate to cling evenly around the shell of the dryer, a condition known as “rimming.” When this occurs, heat transfer efficiency deteriorates.

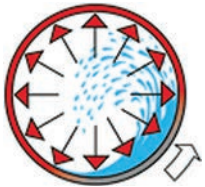

Cascading

Turbulence bars form a cage-like structure around the inside diameter of the cylinder, which disrupts the rimming condensate layer, keeping the condensate turbulent even at very high speeds, thereby maintaining heat transfer efficiency. This improves the uniformity of the dryer surface temperature, ensuring an improved sheet moisture profile. The configuration, spacing and bar size determine the degree of turbulence inside the dryer shell. Turbulence bars are especially effective in combination with stationary siphons.

DEUBLIN turbulence bars clamp securely inside the dryer’s shell, with no troublesome springs or self-tapping screws to fail. Installation is simple and easy, with no special machining or tooling required.

DEUBLIN carbon steel bars also match the thermal expansion characteristics of the dryer vessel, to eliminate failures due to buckling, fretting and excessive wear. Stainless steel turbulence bars are recommended for cooling and swing cylinder applications.

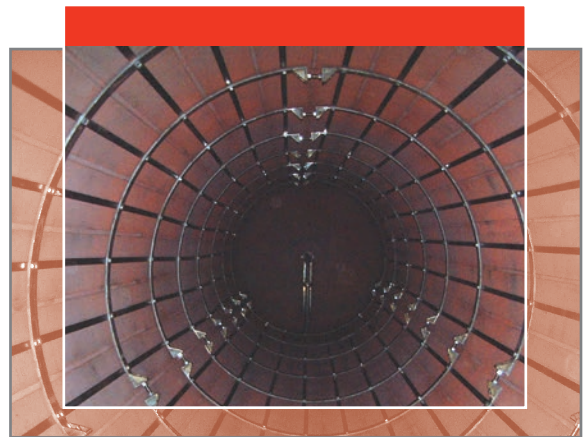

Rimming

DEUBLIN Engineering routinely custom-designs turbulence bars for specific operating conditions.

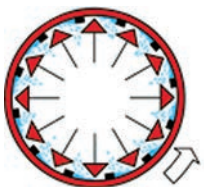

Effect of Turbulence Bars

Sample Machine Direction Average Dryer Surface Temperature with and without Turbulence Bars

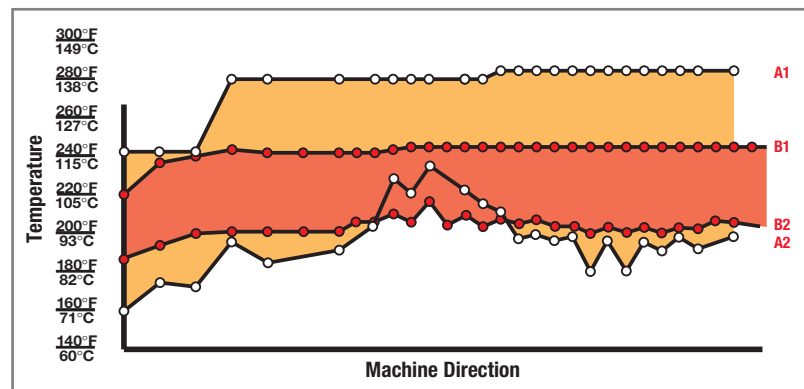

A1 – Steam Temperature Before Conversion
 B1 – Steam Temperature After Conversion
 B2 – Average Dryer Surface Temperature After Conversion
 A2 – Average Dryer Surface Temperature Before Conversion



WARRANTY

For a period of one year from the date of shipment, *DEUBLIN* warrants the products it sells to be free from defects in material and workmanship. The liability of *DEUBLIN* is expressly limited to the replacement or rebuilding of any article, or part thereof, proven defective, when returned to the *DEUBLIN* Company, transportation prepaid, within a reasonable time after the termination of the 365-day warranty period. This warranty is void if the product is dismantled, modified, altered, or damaged from improper maintenance, side-loading, excessive temperature, abrasive, chemical action, or other abuse.

No representative, agent or employee of *DEUBLIN* has any authority to modify the terms of this warranty. *DEUBLIN* will not be responsible for any consequential or resulting damage which may be claimed to have occurred through the sale or use of its products or parts thereof, which might be defective. There are no warranties which extend beyond the description contained under this heading, express or implied, including warranties of fitness for a particular purpose.



REPAIR SERVICE

All *DEUBLIN* rotating unions and siphons can be returned to the factory for professional rebuilding. Components are refurbished to an “as new” condition and carry the same warranty as a new product to ensure optimum performance. Contact *DEUBLIN* Customer Service to arrange repair service.

Unions can be field serviced with repair kits, which are available for most *DEUBLIN* rotating unions. These kits typically include all wear components.



DRYER OPTIMIZATION SEMINAR

DEUBLIN conducts dryer optimization seminars, which typically attract machine superintendents, operators, process and maintenance engineers. The program covers all aspects of dryer optimization. Case studies are presented by Mill personnel with before-and-after data.

Contact *DEUBLIN* Customer Service for further information.

847-689-8600

www.deublin.com

customerservice@deublin.com



IMPROVE EFFICIENCY ENHANCE PRODUCTIVITY

The dryer section has the greatest influence on the economic viability of the entire paper production process. Yet, the dryer section is the most neglected part of the paper machine. Focusing on dryer performance improvement offers the greatest potential for improving the bottom line.

DEUBLIN provides comprehensive services for Steam Systems and Dryer Section Optimization – from equipment supply, system design and integration, installation, to diagnostics and troubleshooting.

Most older paper machines and many newer ones have steam systems that can be optimized to eliminate steam loss, enhance productivity and improve sheet quality. An optimized steam and condensate system also increases throughput, delivers lower drying costs through increased efficiency and increases profits.

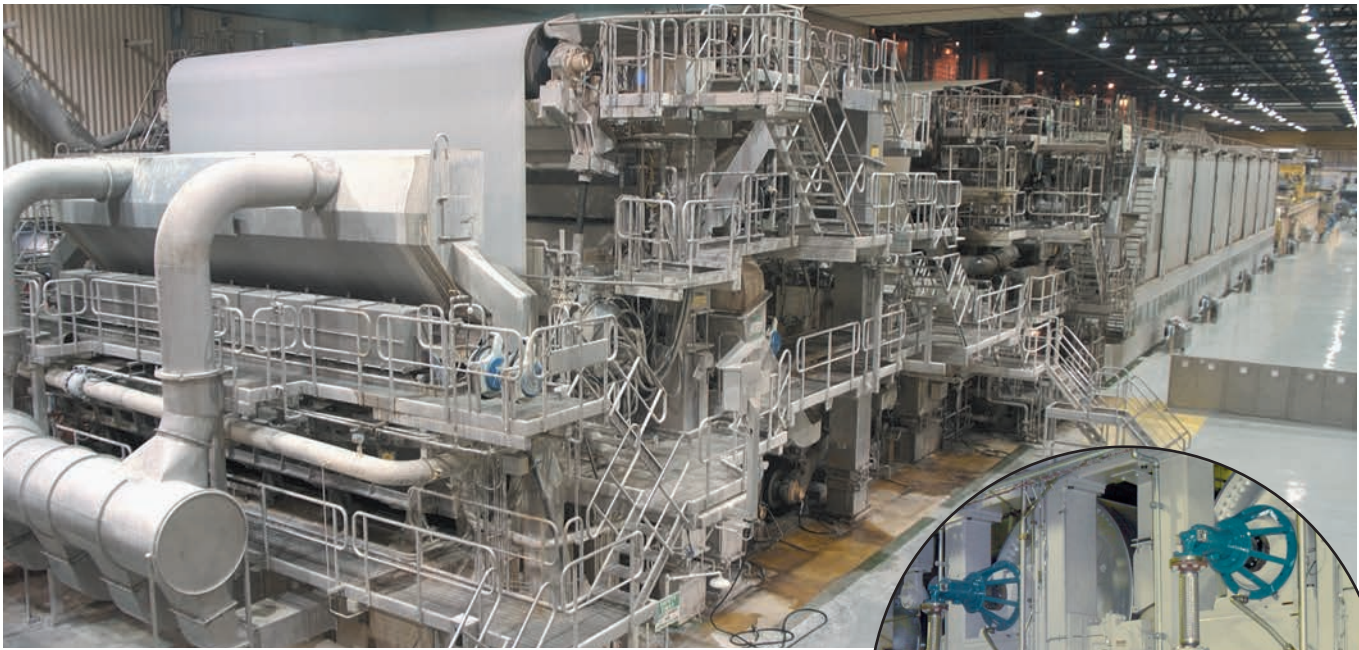

- Eliminate Flooding
- Reduce High Differential Pressure
- Eliminate Steam Venting
- Eliminate Sheet Picking
- Maximize Siphon Reliability
- Maximize Seal Service Life
- Reduce High Motive Steam Usage
- Increase Drying Capacity
- Increase System Flexibility
- Improve Sheet Moisture Profile

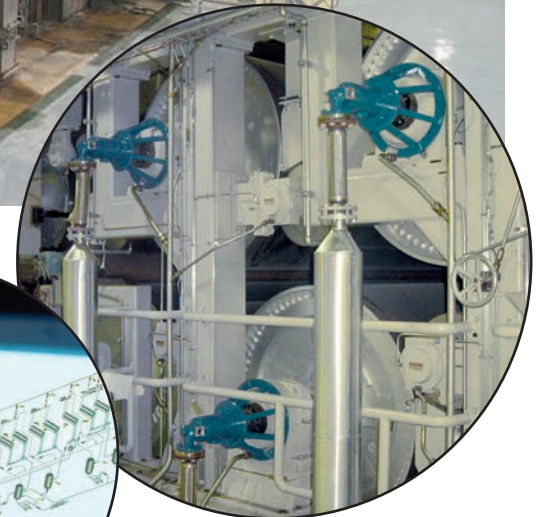
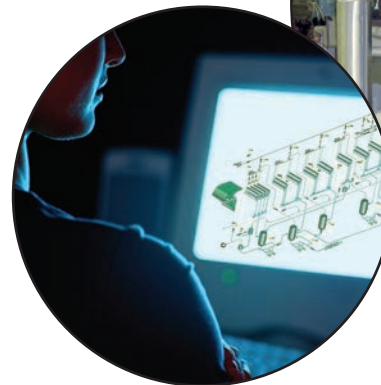

Dryer and Steam System optimization begins with a machine audit. First, we perform a complete system assessment of your dryer section to determine how the existing dryer system is designed, built and operates under a variety of conditions. *DEUBLIN* engineers design around both existing and new components to properly size piping and equipment, adjust pressure loss rates, and ensure proper selection of valves and other devices to meet specific operating targets.

DEUBLIN Steam System dryer optimization services also include:

- Machine Audit
- Installation and Integration
- Diagnostics
- Equipment Supply
- System Design
- Troubleshooting and Routine Service
- Report
- Operator Training

Typical Performance Improvements of a Newsprint Paper Machine after DEUBLIN services are as follows:

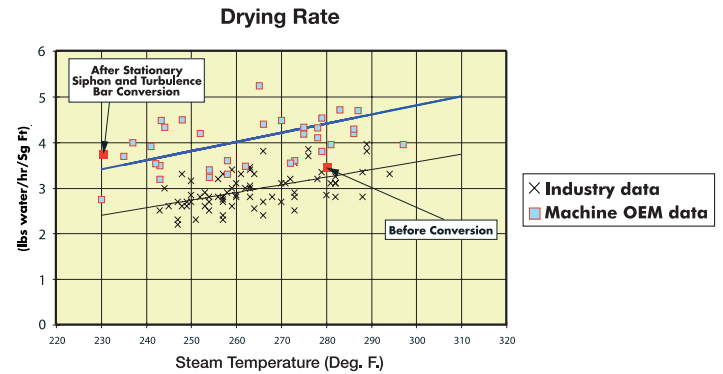
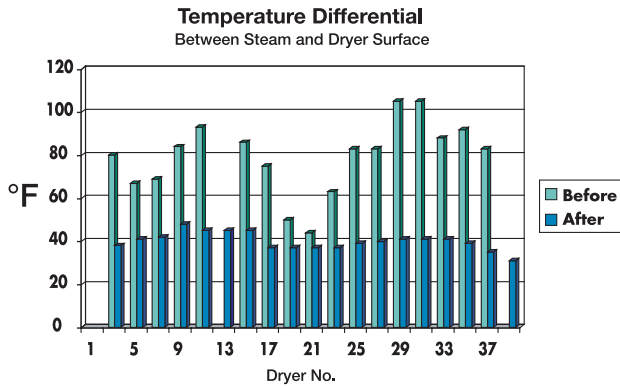

THERMOCOMPRESSOR

Correctly sized thermocompressors minimize motive steam usage and maintain the differential pressure set point under all machine operating conditions. Properly designed thermocompressors are especially suited for operation with a modern, automatic blow-through control strategy, widening the operational range and increasing energy efficiency.

SEPARATOR

High efficiency separators remove condensate from the blow-through steam bringing condensate carryover to an absolute minimum. This eliminates erosion of system components and increases heat transfer. Accurate and consistent blow-through steam flow measurements, critical for system control, also require the high efficiency water removal provided by these separators.

VALVES, TRANSMITTERS, CONTROL SYSTEM AND STRATEGIES

All of the system control elements must be selected and specified based on paper grades produced, furnish, steam supply constraints, operating parameters and control strategies, consistent with quality production and energy efficiency. Components are selected and applied to provide durable, reliable performance consistent with the use of the most modern automation hardware and programming. This combination will allow the papermaker to truly optimize the performance of the dryer section.

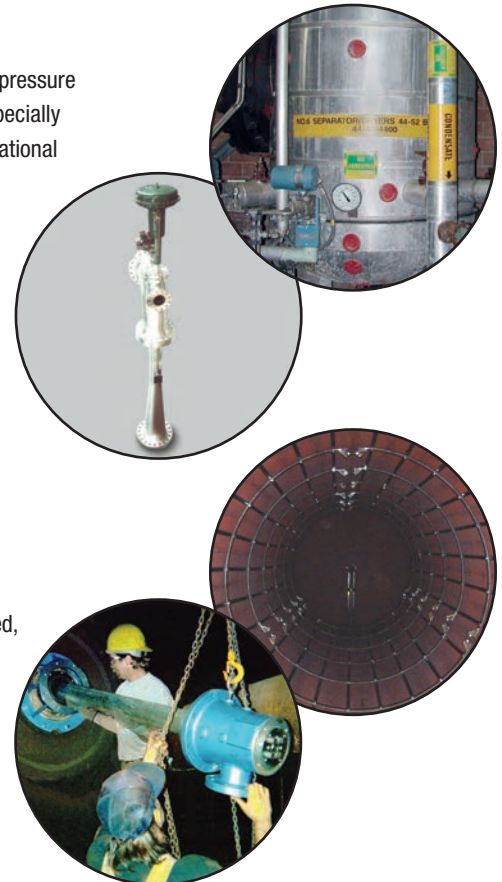

WARNING DEUBLIN unions should not be used to convey flammable media (flash point $\leq 140^{\circ}\text{F}$ or 60°C) as leakage may result in explosions or fires. DEUBLIN unions should be used in accordance with standard safety guidelines for the media, and in a well-ventilated area. The use of our product on hazardous or corrosive media is strictly forbidden.



Since its establishment in 1945, Deublin has consistently adhered to a policy of producing the best product of its kind in the market. The result of this policy has been constant growth through the years. For this progress we are grateful to our many loyal customers. We cordially invite you to visit our modern manufacturing facilities in Waukegan, Illinois; Mainz, Germany; Monteveglio, Italy; and Dalian, China.

Sincerely,

Donald L. Deubler
Chairman of the Board



Global Headquarters in Waukegan, Illinois, U.S.A.



Mainz, Germany



Monteveglio, Italy



Dalian, China



Deublin products & services are available throughout the world.

www.deublin.com

AMERICAS

DEUBLIN USA

2050 Norman Drive
Waukegan, IL 60085-6747 U.S.A.
Phone: +1 847 689-8600
Fax: +1 847 689-8690
e-mail: customerservice@deublin.com

DEUBLIN Brazil

Rua Fagundes de Oliveira, 538 - A11 - Piraporinha
CEP: 09950-300 - Diadema - SP - Brazil
Phone: +55 11-2455-3245
Fax: +55 11-2455-2358
e-mail: deublinbrasil@deublinbrasil.com.br

DEUBLIN Mexico

Norte 79-A No. 77, Col. Claveria
02080 Mexico, D.F.
Phone: +52 55-5342-0362
Fax: +52 55-5342-0157
e-mail: deublin@prodigy.net.mx

ASIA

DEUBLIN China

No. 2, 7th Street, DD Port,
Economic Development Zone, Dalian,
Liaoning Province, 116620, P.R. China
Phone: +86 411-87549678
Fax: +86 411-87549679
e-mail: info@deublin.cn

Room15A07, Wangjiao Plaza
No.175 East Yan'an Road, Huangpu District
Shanghai, 200041, P.R. China
Phone: +86 21-52980791
Fax: +86 21-52980790
e-mail: service@deublin.cn

DEUBLIN Asia Pacific

51 Goldhill Plaza, #11-11/12
Singapore 308900
Phone: +65 6259-9225
Fax: +65 6259-9723
e-mail: deublin@singnet.com.sg

DEUBLIN Japan

2-13-1, Minamihanayashiki
Kawanishi City 666-0026, Japan
Phone: +81 72-757-0099
Fax: +81 72-757-0120
e-mail: customerservice@deublin-japan.co.jp

2-4-10-3F Ryogoku
Sumida-Ku, Tokyo 130-0026, Japan
Phone: +81 35-625-0777
Fax: +81 35-625-0888
e-mail: customerservice@deublin-japan.co.jp

DEUBLIN Korea

Star Tower #1003, Sangdaewon-dong 223-25,
Jungwon-gu, Seongnam-si, Gyeonggi-do,
South Korea
Phone: +82-31-8018-5777
Fax: +82-31-8018-5780
e-mail: customerservice@deublin.co.kr

EUROPE

DEUBLIN Germany

Florenz - Allee 1
55129 Mainz, Germany
Phone: +49 6131-4998-0
Fax: +49 6131-4998-109
e-mail: info@deublin.de

DEUBLIN Italy

Via Guido Rossa, 9
40053 Comune di Valsamoggia (BO), Italy
Phone: +39 051-835611
Fax: +39 051-832091
e-mail: info@deublin.it

DEUBLIN Austria

Lainzer Strasse 35
1130 Vienna
Phone: +43 1-8768450
Fax: +43 1-876845030
e-mail: info@deublin.at

DEUBLIN France

61 bis, Avenue de l'Europe
Z.A.C de la Malnoue
77184 Emerainville, France
Phone: +33 1-64616161
Fax: +33 1-64616364
e-mail: service.client@deublin.fr

DEUBLIN Poland

ul. Kamienskiego 201-219
51-126 Wroclaw, Poland
Phone: +48 71-3528152
Fax: +48 71-3276278
e-mail: info@deublin.pl

DEUBLIN Russia

ul. Kosygina, 13, 5th entrance, 1-st floor
119334, Moscow, Russia
Phone: +7 495 647-14-34
Fax: +7 495 938-89-49
e-mail: info@deublinrussia.ru

DEUBLIN Spain

C/Lola Anglada, 20 local 1,
08228 Terrassa, Spain
Phone: +34 93-2211223
Fax: +34 93-2212093
e-mail: deublin@deublin.es

DEUBLIN Sweden

Cylindervägen 18, Box 1113
13 126 Nacka Strand, Sweden
Phone: +46 8 716 2033
Fax: +46 8 601 3033
e-mail: info@deublin.se

DEUBLIN United Kingdom

6 Sopwith Park, Royce Close,
West Portway
Andover SP10 3TS, UK
Phone: +44 1264-333355
Fax: +44 1264-333304
e-mail: info@deublin.co.uk